

# Line monitoring relay

70  
SERIES



Air  
conditioners



Wood-  
processing  
machines



Hoists and  
cranes



Escalators



Control panels  
for pumps



Forced-air  
ventilators





**Electronic voltage monitoring relays for single and three-phase applications**

- Multifunctional types, providing the flexibility of monitoring Undervoltage, Overvoltage, Window Mode, Phase rotation, Phase loss
- Positive safety logic - Make output contact opens if the relay detects an error
- All functions and values can be easily adjusted by the selector and trimmer on front face
- "Blade + cross" – both flat blade and cross head screw drivers can be used to adjust the regulators and the function selector
- Colored LEDs for clear & immediate visual indication
- 1 CO relay output, 6 or 10 A
- Modular housing, 17.5 or 35 mm wide
- 35 mm rail (EN 60715) mount
- Cd-free contact material

Screw terminal



For outline drawing see page 13

**Contact specification**

Contact configuration		1 CO (SPDT)	1 CO (SPDT)
Rated current/Maximum peak current	A	10/30	6/10
Rated voltage/Max. switching voltage	V AC	250/400	250/400
Rated load AC1	VA	2500	1500
Rated load AC15	VA	750	500
Single phase motor rating (230 V AC)	kW	0.5	0.185
Breaking capacity DC1: 30/110/220 V	A	10/0.3/0.12	6/0.2/0.12
Minimum switching load	mW (V/mA)	300 (5/5)	500 (12/10)
Standard contact material		AgNi	AgNi

**Supply specification**

Nominal system voltage (U <sub>N</sub> )	V AC (50/60 Hz)	220...240	380...415
Rated power	VA (50 Hz)/W	2.6/0.8	11/0.9
Operating range	V AC (50/60 Hz)	130...280	220...510

**Technical data**

Electrical life at rated load AC1	cycles	80 · 10 <sup>3</sup>	60 · 10 <sup>3</sup>
Voltage detection level range	V	170...270	300...480
Asymmetry detection level range	%	—	—
Switch-off delay time (T on function diagrams)	s	0.5...60	0.5...60
Switch-on lock-out time	s	0.5	1
Switch-on hysteresis (H on function diagrams)	V	5 (L-N)	10 (L-L)
Power-on activation time	s	≈ 1	≈ 1
Insulation between supply and contacts (1.2/50 μs)	kV	4	4
Dielectric strength between open contacts	V AC	1000	1000
Ambient temperature	°C	-20...+60	-20...+60
Protection category		IP 20	IP 20

**Approvals** (according to type)



**70.11**



Single-phase (220...240)V voltage monitoring:

- Undervoltage
- Overvoltage
- Window mode (overvoltage + undervoltage)
- Voltage fault memory selectable

**70.31**



Three-phase (380...415)V voltage monitoring:

- Undervoltage
- Overvoltage
- Window mode (overvoltage + undervoltage)
- Voltage fault memory selectable
- Phase loss, even under phase regeneration
- Phase rotation

**Electronic voltage monitoring relays for three-phase applications**

- Multifunctional types, providing the flexibility of monitoring Undervoltage, Overvoltage, Window Mode, Phase rotation, Phase loss, Asymmetry and Neutral loss
- Phase loss monitoring, even under phase regeneration
- Positive safety logic - Make output contact opens if the relay detects an error
- All functions and values can be easily adjusted by the selector and trimmer on front face
- "Blade + cross" – both flat blade and cross head screw drivers can be used to adjust the regulators and the function selector
- Colored LEDs for clear & immediate visual indication
- 1 or 2 CO relay output, 6 or 8 A
- Modular housing, 35 mm wide
- 35 mm rail (EN 60715) mount
- Cd-free contact material

Screw terminal



For outline drawing see page 13

**Contact specification**

		70.41	70.42
Contact configuration		1 CO (SPDT)	2 CO (DPDT)
Rated current/Maximum peak current	A	6/10	8/15
Rated voltage/ Max. switching voltage	V AC	250/400	250/400
Rated load AC1	VA	1500	2000
Rated load AC15	VA	500	400
Single phase motor rating (230 V AC)	kW	0.185	0.3
Breaking capacity DC1: 30/110/220 V	A	6/0.2/0.12	8/0.3/0.12
Minimum switching load	mW (V/mA)	500 (12/10)	300 (5/5)
Standard contact material		AgNi	AgNi

**Supply specification**

		70.41	70.42
Nominal system voltage ( $U_N$ )	V AC (50/60 Hz)	380...415	380...415
Rated power	VA (50 Hz)/W	11/0.9	12.5/1
Operating range	V AC (50/60 Hz)	220...510	220...510

**Technical data**

		70.41	70.42
Electrical life at rated load AC1	cycles	$60 \cdot 10^3$	$60 \cdot 10^3$
Voltage detection level range	V	300...480	300...480
Asymmetry detection level range	%	4...25	5...25
Switch-off delay time (T on function diagrams)	s	0.5...60	0.5...60
Switch-on lock-out time	s	1	1
Switch-on hysteresis (H on function diagrams)	V	10 (L-L)	10 (L-L)
Power-on activation time	s	$\approx 1$	$\approx 1$
Insulation between supply and contacts (1.2/50 $\mu$ s)	kV	4	4
Dielectric strength between open contacts	V AC	1000	1000
Ambient temperature	$^{\circ}$ C	-20...+60	-20...+60
Protection category		IP 20	IP 20

**Approvals** (according to type)

**70.41**

Three-phase (380...415 V, with or without neutral) voltage monitoring:

- Window mode (overvoltage + undervoltage)
- Phase loss
- Phase rotation
- Asymmetry
- Neutral loss selectable

**70.42**

Three-phase (380...415 V, with neutral) voltage monitoring:

- Undervoltage
- Overvoltage
- Window mode (overvoltage + undervoltage)
- Voltage fault memory selectable
- Phase loss
- Phase rotation
- Asymmetry
- Neutral loss

**Electronic phase loss and rotation monitoring relays for three-phase applications**

- Universal voltage monitoring ( $U_N$  from 208 V to 480 V, 50/60 Hz)
- Phase loss monitoring, even under phase regeneration
- Positive safety logic - Make contact opens if the relay detects an error
- 2 versions:  
1 CO relay output, 6 A (17.5 mm wide), and  
2 CO relay output, 8 A (22.5 mm wide)
- 35 mm rail (EN 60715) mount
- European patent pending for the innovative principle at the root of the 3 phase monitoring and error survey system (70.61)

Screw terminal



For outline drawing see page 13

**Contact specification**

Contact configuration		1 CO (SPDT)	2 CO (DPDT)
Rated current/Maximum peak current	A	6/15	8/15
Rated voltage/ Max. switching voltage	V AC	250/400	250/400
Rated load AC1	VA	1500	2000
Rated load AC15	VA	250	400
Single phase motor rating (230 V AC)	kW	0.185	0.3
Breaking capacity DC1: 30/110/220 V	A	3/0.35/0.2	8/0.3/0.12
Minimum switching load	mW (V/mA)	500 (10/5)	300 (5/5)
Standard contact material		AgSnO <sub>2</sub>	AgNi

**Supply specification**

Nominal system voltage ( $U_N$ )	V AC (50/60 Hz)	208...480	208...480
Rated power	VA (50 Hz)/W	8/1	11/0.8
Operating range	V AC (50/60 Hz)	170...500	170...520

**Technical data**

Electrical life at rated load AC1	cycles	100 · 10 <sup>3</sup>	60 · 10 <sup>3</sup>
Switch-off delay time	s	0.5	0.5
Switch-on lock-out time	s	0.5	0.5
Power-on activation time	s	< 2	< 2
Insulation between supply and contacts (1.2/50 μs)	kV	5	5
Dielectric strength between open contacts	V AC	1000	1000
Ambient temperature	°C	-20...+60	-20...+60
Protection category		IP 20	IP 20

**Approvals** (according to type)



**70.61**



Three-phase (208...480)V  
voltage monitoring:

- Phase loss
- Phase rotation

**70.62**



Three-phase (208...480)V  
voltage monitoring:

- Phase loss
- Phase rotation

## Ordering information

Example: 70 series, three-phase voltage monitoring relay, 1 output, supply voltage 380...415 V AC.

7 0 . 3 1 . 8 . 4 0 0 . <sup>A</sup>2 . <sup>B</sup>0 . <sup>C</sup>2 . <sup>D</sup>2

### Series

### Type

1 = 1 phase AC line monitoring  
3 = 3 phase AC line monitoring  
4 = 3 phase + neutral AC line monitoring  
6 = 3 phase loss and rotation monitoring

### No. of poles

1 = 1 pole  
2 = 2 pole

### Supply version

8 = AC (50/60 Hz)

### Supply voltage

230 = 220...240 V (70.11)  
400 = 380...415 V (70.31/41/42)  
400 = 208...480 V (70.61/62)

### D: Fault memory option

0 = No fault memory  
2 = Fault memory function selectable

### C: Time delay setting

0 = Fixed switch-off delay  
2 = Adjustable switch-off delay  
3 = Adjustable switch-off delay and asymmetry

### B: Contact circuit

0 = CO (nPDT)

### A: Detection values

0 = Non-adjustable detection values  
2 = 2 adjustable detection values

### Codes

70.11.8.230.2022	70.42.8.400.2032
70.31.8.400.2022	70.61.8.400.0000
70.41.8.400.2030	70.62.8.400.0000

## Selection guide

Type	70.11.8.230.2022	70.31.8.400.2022	70.41.8.400.2030	70.42.8.400.2032	70.61.8.400.0000	70.62.8.400.0000
Supply system type	Single phase	3-phase	3-phase / 3-phase + neutral	3-phase + neutral	3-phase	3-phase
<b>Functions</b>						
Undervoltage/Overvoltage	AC	AC	—	AC	—	—
Window mode (Undervoltage and Overvoltage)	AC	AC	AC	AC	—	—
Phase loss	—	•	•	•	•	•
Phase rotation	—	•	•	•	•	•
Asimmetry	—	—	•	•	—	—
Neutral loss	—	—	•	•	—	—
Overcurrent/Undercurrent	—	—	—	—	—	—
Window mode (Undercurrent and Overcurrent)	—	—	—	—	—	—
Thermistor relay (PTC)	—	—	—	—	—	—
<b>Delay Times</b>						
Fixed	—	—	—	—	•	•
Adjustable	•	•	•	•	—	—
<b>Supply voltage</b>						
24 V AC/DC	—	—	—	—	—	—
230 V AC	•	—	—	—	—	—
400 V AC	—	•	•	•	•	•
<b>Module width</b>						
35 mm wide	—	•	•	•	—	—
22.5 mm wide	—	—	—	—	—	•
17.5 mm wide	•	—	—	—	•	—
<b>Other data</b>						
Fault memory	•	•	—	•	—	—
Contact configuration	1 CO	1 CO	1 CO	2 CO	1 CO	2 CO

See selection guide for 71 series functions

## Technical data

<b>Insulation</b>			<b>70.11/31/41/42</b>	<b>70.61</b>	<b>70.62</b>
Between supply and contacts	dielectric strength	V AC	2500	2500	3000
	impulse (1.2/50 µs)	kV	4	5	5
Between open contacts	dielectric strength	V AC	1000	1000	1000
	impulse (1.2/50 µs)	kV	1.5	1.5	1.5
<b>EMC specifications</b>					
<b>Type of test</b>			<b>Reference standard</b>		
Electrostatic discharge	contact discharge		EN 61000-4-2	4 kV	
	air discharge		EN 61000-4-2	8 kV	
Radiated electromagnetic field	80...1000 MHz		EN 61000-4-3	10 V/m	
	1...2.8 GHz		EN 61000-4-3	5 V/m	
Fast transients (burst 5/50 ns, 5 and 100 kHz)	on supply terminals		EN 61000-4-4	4 kV	
Voltage pulses on supply terminals (surge 1.2/50 µs)	common mode		EN 61000-4-5	4 kV	
	differential mode		EN 61000-4-5	4 kV	
Radiofrequency common mode voltage (0.15...230 MHz)	on supply terminals		EN 61000-4-6	10 V	
Voltage dips	70% U <sub>N</sub>		EN 61000-4-11	25 cycles	
Short interruptions			EN 61000-4-11	1 cycle	
Radiofrequency conducted emissions	0.15...30 MHz		CISPR 11	class B	
Radiated emissions	30...1000 MHz		CISPR 11	class B	
<b>Terminals</b>			<b>solid cable</b>	<b>stranded cable</b>	
Max. wire size		mm <sup>2</sup>	1 x 6 / 2 x 4	1 x 4 / 2 x 2.5	
		AWG	1 x 10 / 2 x 12	1 x 12 / 2 x 14	
Screw torque		Nm	0.8		
Wire strip length		mm	9		
<b>Other data</b>			<b>70.11</b>	<b>70.31/41</b>	<b>70.42/61/62</b>
Power lost to the environment	without output current	W	0.8	0.9	1
	with rated output current	W	2	1.2	1.4

E

## Functions

Output relay On (NO closed) when all OK: positive logic.

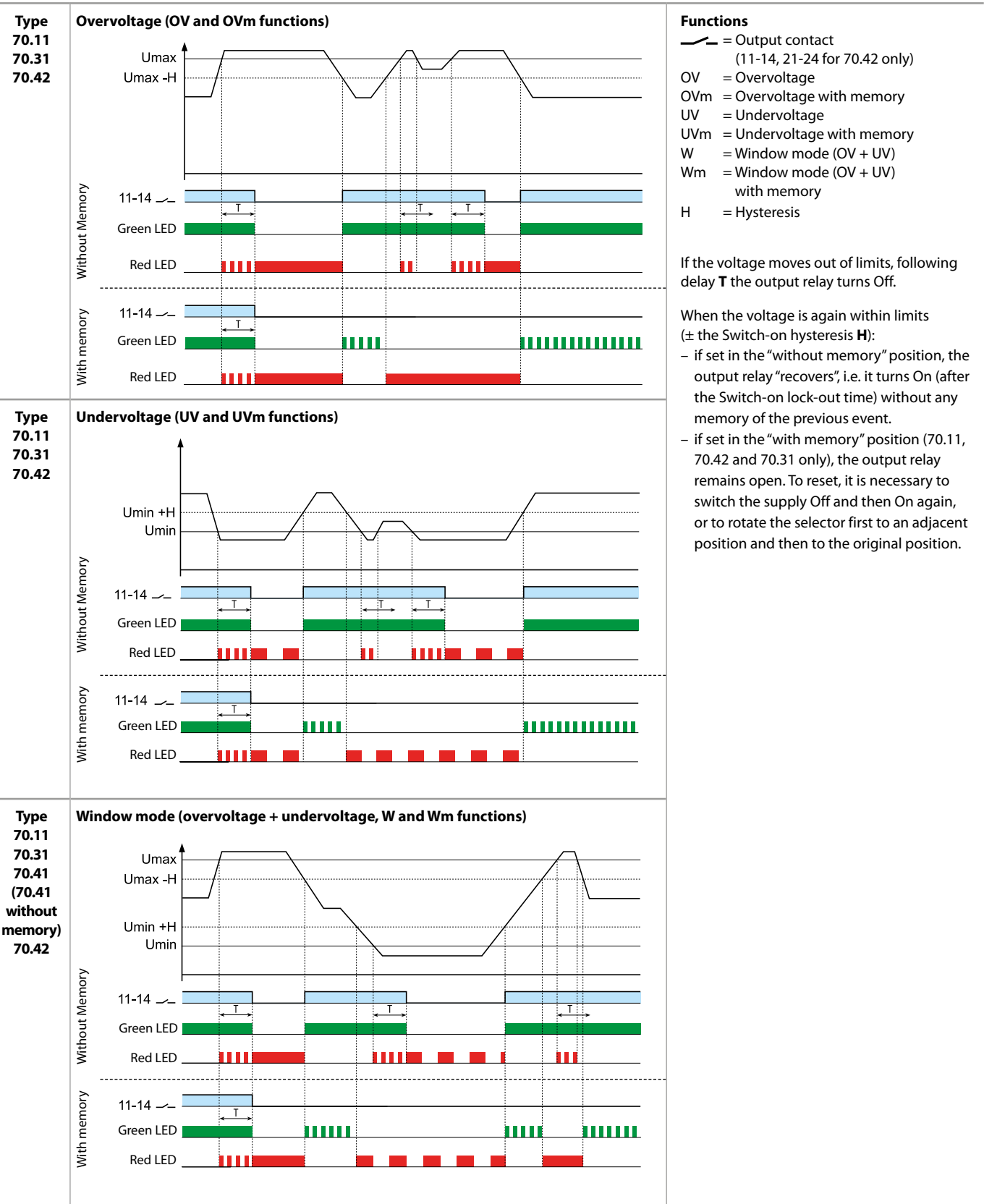



## Functions

Output relay On (NO closed) when all OK: positive logic.

<p><b>Type</b> 70.31 70.41 70.42 70.61 70.62</p>	<p><b>Phase loss and phase rotation</b></p>	<p>If the sequence (L1, L2, L3) is incorrect at power-on, the output relay will not turn-on.</p> <p>If a phase is lost, the output relay turns off immediately. When the phase is again active, the output relay turns on immediately.</p> <p>Phase loss monitoring possible even under regeneration up to 80% of the average of the other 2 phases.</p>
<p><b>Type</b> 70.41 70.42</p>	<p><b>Neutral loss and asymmetry</b></p>	<p>If the neutral is lost (and the Neutral control function is set), the output relay turns off immediately. When the neutral is again present, the output relay turns on immediately.</p> <p>If the asymmetry <math>(U_{max} - U_{min})/U_N</math> is above the % set value, the output relay turns off after the set delay <b>T</b>. When the asymmetry is again below the % set value (with a fixed hysteresis of approximately 2%), the output relay turns on after the Switch-on lock-out time.</p>

E

Front view: function selector and regulators

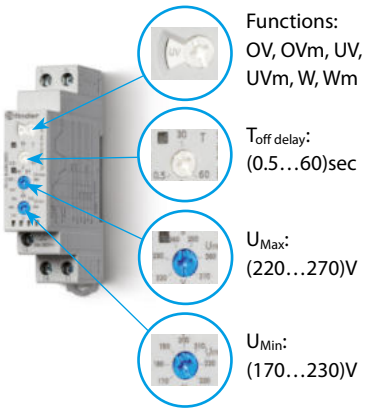
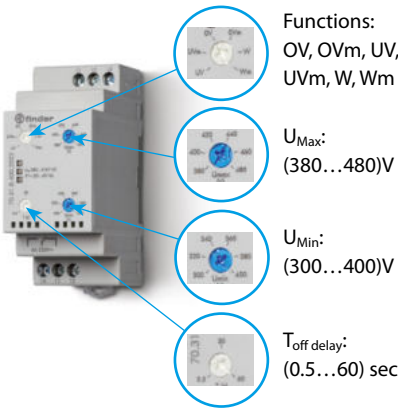
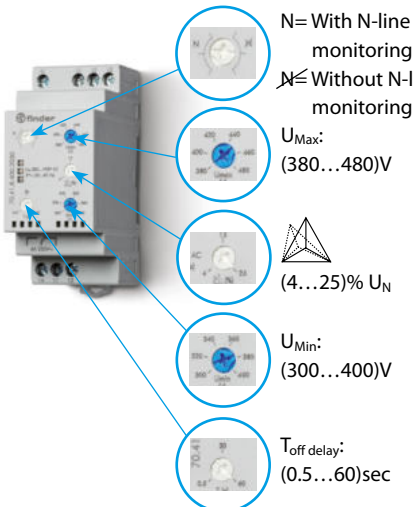
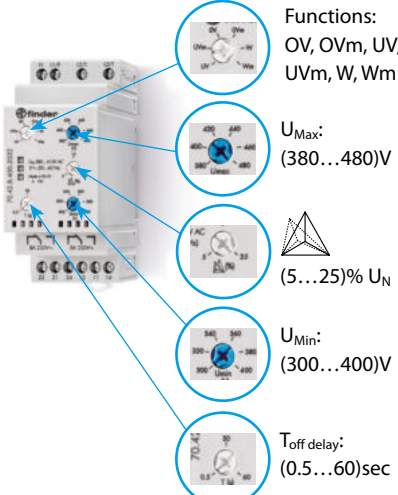
<p><b>70.11</b></p>  <p>Functions: OV, OVm, UV, UVm, W, Wm</p> <p>T<sub>off</sub> delay: (0.5...60)sec</p> <p>U<sub>Max</sub>: (220...270)V</p> <p>U<sub>Min</sub>: (170...230)V</p>	<p><b>70.31</b></p>  <p>Functions: OV, OVm, UV, UVm, W, Wm</p> <p>U<sub>Max</sub>: (380...480)V</p> <p>U<sub>Min</sub>: (300...400)V</p> <p>T<sub>off</sub> delay: (0.5...60) sec</p>	<p><b>70.41</b></p>  <p>N= With N-line monitoring N≠ Without N-line monitoring</p> <p>U<sub>Max</sub>: (380...480)V</p> <p>(4...25)% U<sub>N</sub></p> <p>U<sub>Min</sub>: (300...400)V</p> <p>T<sub>off</sub> delay: (0.5...60)sec</p>
<p><b>70.42</b></p>  <p>Functions: OV, OVm, UV, UVm, W, Wm</p> <p>U<sub>Max</sub>: (380...480)V</p> <p>(5...25)% U<sub>N</sub></p> <p>U<sub>Min</sub>: (300...400)V</p> <p>T<sub>off</sub> delay: (0.5...60)sec</p>		

E

LED indication

Monitoring relay Type	LED	Supply system normal	Supply system abnormal (Voltage out of limits, switch-off delay time T running)	Supply system abnormal (Reason for switch-off, RESET necessary when "with Memory" is selected)
		Contact 11 - 14 closed	Contact 11 - 14 closed	Contact 11-14 open
70.11.8.230.2022	• •		 	Overvoltage OV and OVm Undervoltage UV and UVm With Memory, following a failure a manual "RESET" ** is necessary
70.31.8.400.2022	• • •		 	Overvoltage OV and OVm Undervoltage UV and UVm Phase loss Phase rotation With Memory, following a failure a manual "RESET" ** is necessary
70.41.8.400.2030	• • •		 	Overvoltage OV Undervoltage UV Asymmetry Phase loss Neutral loss Phase rotation
70.42.8.400.2032	• • •		 	Overvoltage OV and OVm Undervoltage UV and UVm Asymmetry Phase loss Neutral loss Phase rotation With Memory, following a failure a manual "RESET" ** is necessary
70.61.8.400.0000	•			Phase rotation or Phase loss
70.62.8.400.0000	•			Phase loss Phase rotation

\* The function "with Memory" is only available for type 70.11, 70.42 and 70.31.

\*\* It is necessary to switch the supply OFF and then On again (U off U on) or to rotate the function selector first to an adjacent position and then to the original position.

Wiring diagrams

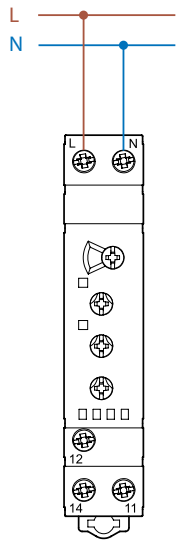

Type 70.11

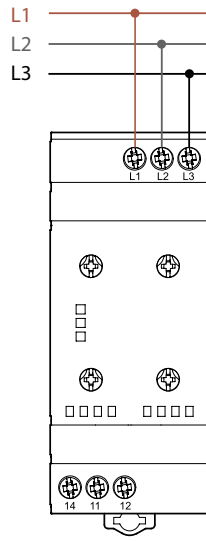

Type 70.31

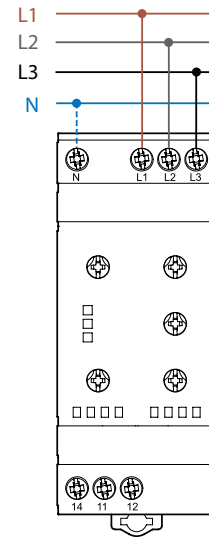

Type 70.41

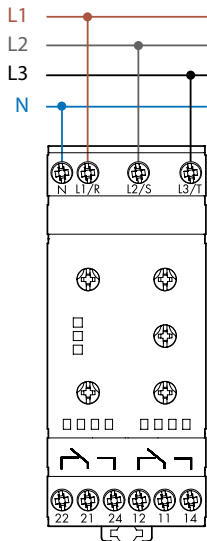

Type 70.42

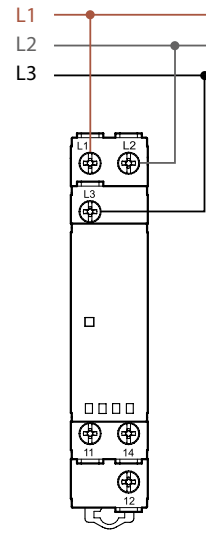

Type 70.61

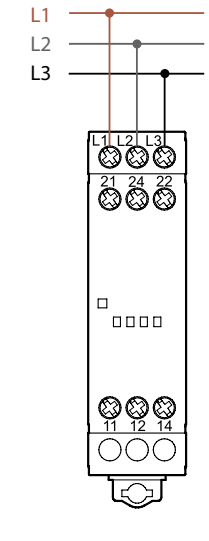

Type 70.62

Application example

The output contact switches the coil of the line contactor.

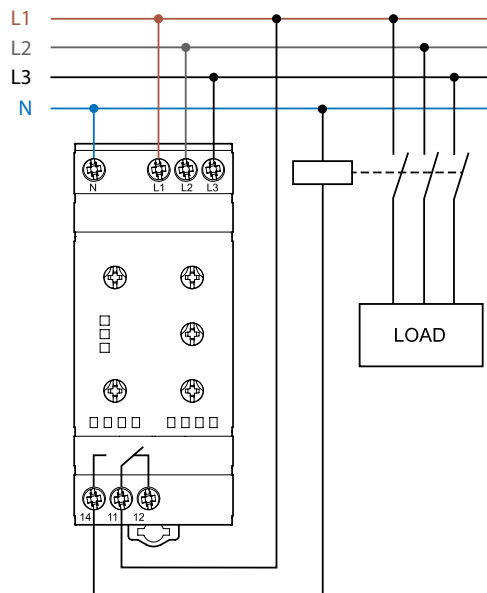

Outline drawings

Type 70.11  
Screw terminal

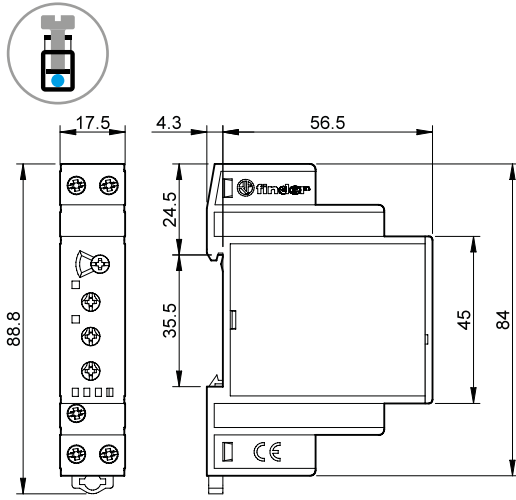

Type 70.31  
Screw terminal

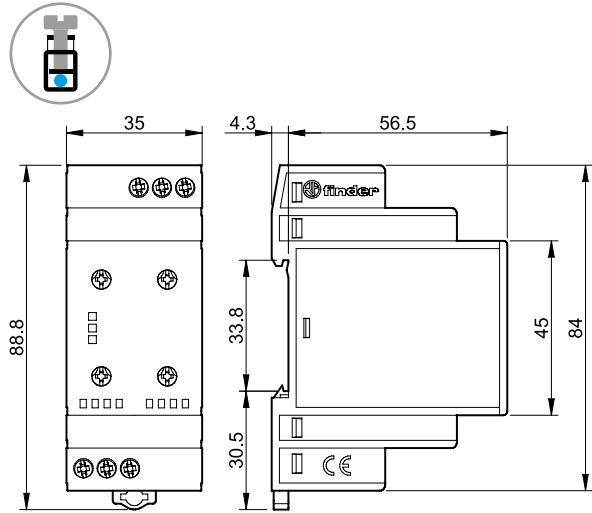

Type 70.41  
Screw terminal

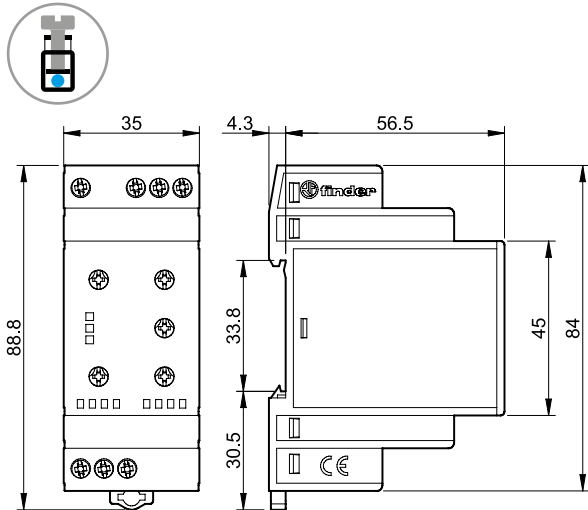

Type 70.42  
Screw terminal

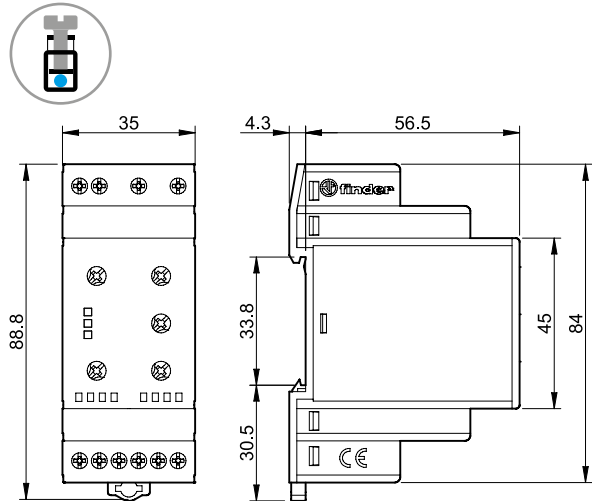

Type 70.61  
Screw terminal

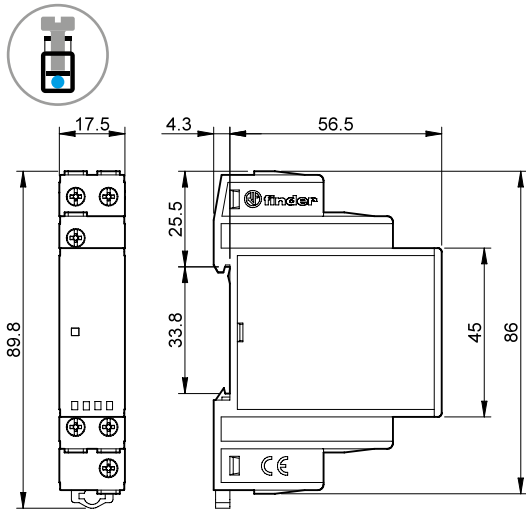

Type 70.62  
Screw terminal

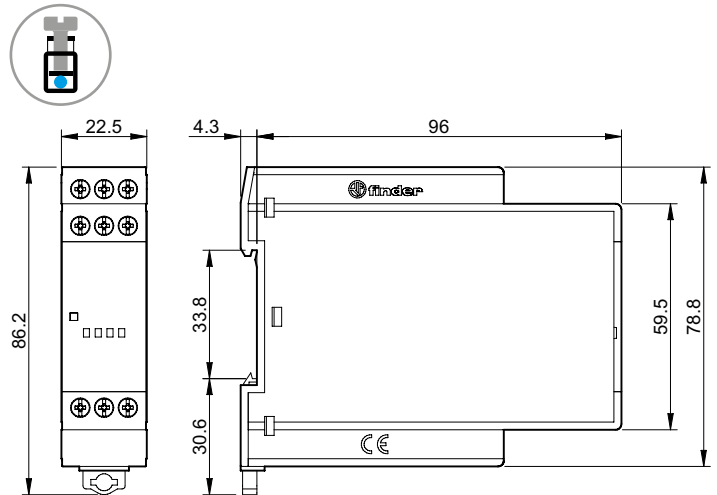

Accessories



020.01

**Adaptor for panel mounting, plastic, 17.5 mm wide for 70.11 and 70.61**

020.01

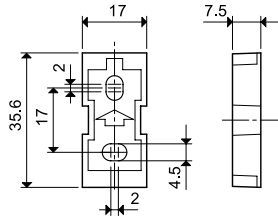

011.01

**Adaptor for panel mounting, plastic, 35 mm wide for 70.31, 70.42 and 70.41**

011.01

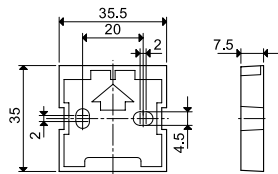

E

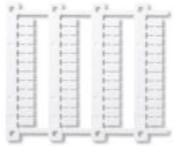

060.48

**Sheet of marker tags (CEMBRE Thermal transfer printers) for relays types 70.11, 70.31, 70.41, 70.42 and 70.62 (48 tags), 6 x 12 mm**

060.48



019.01

**Identification tag, plastic, 1 tag, 17 x 25.5 mm for 70.11, 70.31, 70.42 and 70.41**

019.01



022.09

**Separator for rail mounting, plastic, 9 mm wide**

022.09

