

2 CO power relays with high separation between adjacent contacts
Direct PCB or socket mount

Type 44.52

- 2 CO 6 A (5 mm pin pitch)

Type 44.62

- 2 CO 10 A (5 mm pin pitch)

- DC coils (Standard or sensitive)
- Cadmium Free contact materials
- 8 mm, 6 kV (1.2/50 μs) isolation, coil-contacts
- UL Listing (certain relay/socket combinations)
- 95 series sockets for PCB or 35 mm rail mounting (EN 60715) with Screw, Screwless or Push-in terminals
- Coil Indication and EMC suppression modules 99 series and Timer module 86.30 options
- Environmental protection: RT II - flux proof (Standard)

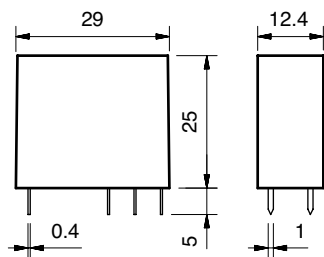

FOR UL RATINGS SEE:

"General technical information" page V

Contact specification

Contact configuration		2 CO (DPDT)	2 CO (DPDT)
Rated current/Maximum peak current	A	6/10	10/20
Rated voltage/Maximum switching voltage	V AC	250/400	250/400
Rated load AC1	VA	1500	2500
Rated load AC15 (230 V AC)	VA	250	500
Single phase motor rating (230 V AC)	kW	0.185	0.37
Breaking capacity DC1: 30/110/220 V	A	6/0.3/0.13	10/0.3/0.13
Minimum switching load	mW (V/mA)	300 (5/5)	300 (5/5)
Standard contact material		AgNi	AgNi

Coil specification

Nominal voltage (U _N)	V AC (50/60 Hz)	—	—
	V DC	6 - 9 - 12 - 14 - 24 - 28 - 48 - 60 - 110 - 125	
Rated power AC/DC/sens. DC	VA (50 Hz)/W/W	—/0.65/0.5	—/0.65/0.5
Operating range	AC	—	—
	DC/sens. DC	(0.73...1.5)U _N / (0.73...1.7)U _N	(0.73...1.5)U _N / (0.8...1.7)U _N
Holding voltage	AC/DC	—/0.4 U _N	—/0.4 U _N
Must drop-out voltage	AC/DC	—/0.1 U _N	—/0.1 U _N

Technical data

Mechanical life AC/DC	cycles	—/20 · 10 ⁶	—/20 · 10 ⁶
Electrical life at rated load AC1	cycles	150 · 10 ³	100 · 10 ³
Operate/release time	ms	8/5 - (12/5 sensitive)	8/5 - (12/5 sensitive)
Insulation between coil and contacts (1.2/50 μs)	kV	6 (8 mm)	6 (8 mm)
Dielectric strength between open contacts	V AC	1000	1000
Ambient temperature range	°C	-40...+85	-40...+85
Environmental protection		RT II	RT II

Approvals (according to type)

44.52



- 2 CO 6 A
- PCB or 95 series sockets

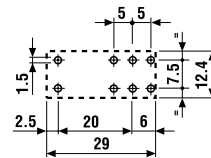
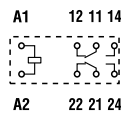

Copper side view

44.62



- 2 CO 10 A
- PCB or 95 series sockets

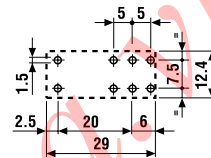
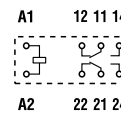

Copper side view

Ordering information

Example: 44 series PCB relay, 2 CO 10 A contacts, 24 V DC coil.

A

4 4 . 6 2 . 9 . 0 2 4 . 0 0 0 0

Series
Type

5 = PCB - 5 mm pinning
6 = PCB - 5 mm pinning

No. of poles

2 = 2 pole for
44.52, 6 A
44.62, 10 A

Coil version

7 = Sensitive DC
9 = DC

Coil voltage

See coil specifications

A: Contact material

0 = Standard AgNi
4 = AgSnO₂
for 44.62 only
5 = AgNi + Au
for 44.52 only

B: Contact circuit

0 = CO (DPDT)

D: Special versions

0 = Flux proof (RT II)

C: Options

0 = None

Selecting features and options: only combinations in the same row are possible.

Preferred selections for best availability are shown in **bold**.

Type	Coil version	A	B	C	D
44.52	DC - sens. DC	0 - 5	0	0	0
44.62	DC - sens. DC	0 - 4	0	0	0

Technical data

Insulation according to EN 61810-1

Nominal voltage of supply system	V AC	230/400	
Rated insulation voltage	V AC	250	400
Pollution degree		3	2

Insulation between coil and contact set

Type of Insulation		Reinforced (8 mm)
Overvoltage category		III
Rated impulse voltage	kV (1.2/50 μs)	6
Dielectric strength	V AC	4000

Insulation between adjacent contacts

Type of insulation		Basic
Overvoltage category		III
Rated impulse voltage	kV (1.2/50 μs)	4
Dielectric strength	V AC	2500

Insulation between open contacts

Type of disconnection		Micro-disconnection
Dielectric strength	V AC/kV (1.2/50 μs)	1000/1.5

Conducted disturbance immunity

Burst (5...50)ns, 5 kHz, on A1 - A2	EN 61000-4-4	level 4 (4 kV)
Surge (1.2/50 μs) on A1 - A2 (differential mode)	EN 61000-4-5	level 3 (2 kV)

Other data

Bounce time: NO/NC	ms	4/4	
Vibration resistance (5...55)Hz: NO/NC	g	15/12	
Shock resistance	g	16	
Power lost to the environment	without contact current	W	0.6
	with rated current	W	1.2 (44.52) 2.7 (44.62)
Recommended distance between relays mounted on PCB	mm	≥5	

Contact specification

F 44 - Electrical life (AC) v contact current

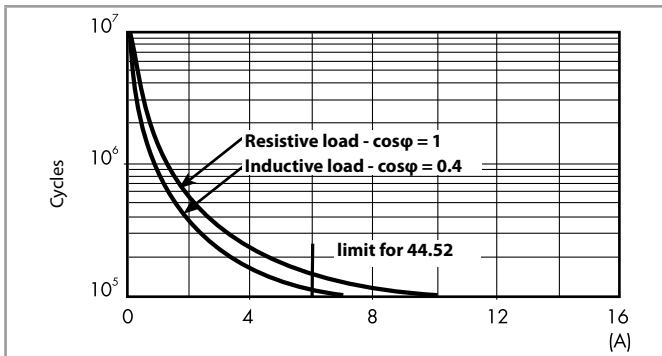

H 44 - Maximum DC1 breaking capacity

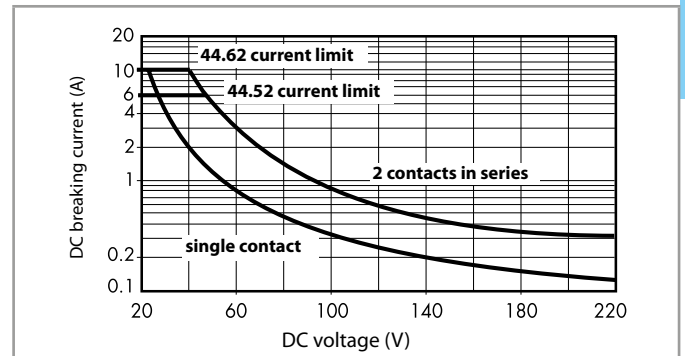

- When switching a resistive load (DC1) having voltage and current values under the curve, an electrical life of $\geq 100 \cdot 10^3$ can be expected.
- In the case of DC13 loads, the connection of a diode in parallel with the load will permit a similar electrical life as for a DC1 load.
Note: the release time for the load will be increased.

Coil specifications

DC coil data - 0.65 W standard

Nominal voltage U_N V	Coil code	Operating range		Resistance R Ω	Rated coil consumption I at U_N mA
		U_{min} V	U_{max} V		
6	9.006	4.4	9	55	109
9	9.009	6.6	13.5	125	72
12	9.012	8.8	18	220	55
14	9.014	10.2	21	300	47
24	9.024	17.5	36	900	27
28	9.028	20.5	42	1200	23
48	9.048	35	72	3500	14
60	9.060	43.8	90	5500	11
110	9.110	80.3	165	18000	6.2
125	9.125	91.2	188	23500	5.3

DC coil data - 0.5 W sensitive

Nominal voltage U_N V	Coil code	Operating range		Resistance R Ω	Rated coil consumption I at U_N mA
		U_{min} V	U_{max} V		
6	7.006	4.4	10.2	75	80
9	7.009	6.6	15.3	160	56
12	7.012	8.8	20.4	300	40
14	7.014	10.2	23.8	400	35
24	7.024	17.5	40.8	1200	20
28	7.028	20.5	47.6	1600	17.5
48	7.048	35	81.6	4800	10
60	7.060	43.8	102	7200	8.4
110	7.110	80.3	187	23500	4.7
125	7.125	100	219	32000	3.9

* $U_{min} = 0.8 U_N$ for 44.62

R 44 - DC coil operating range v ambient temperature
Standard coil

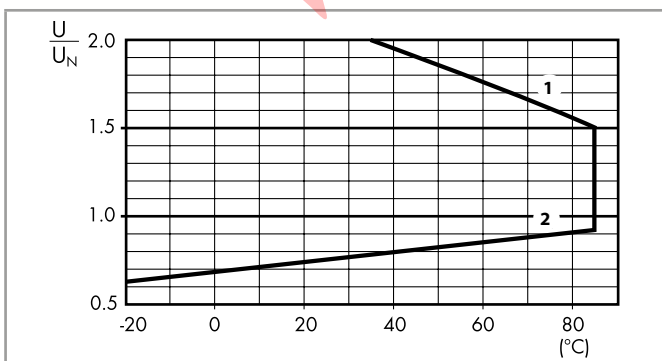

- 1 - Max. permitted coil voltage.
2 - Min. pick-up voltage with coil at ambient temperature.

R 44 - DC coil operating range v ambient temperature
Sensitive coil

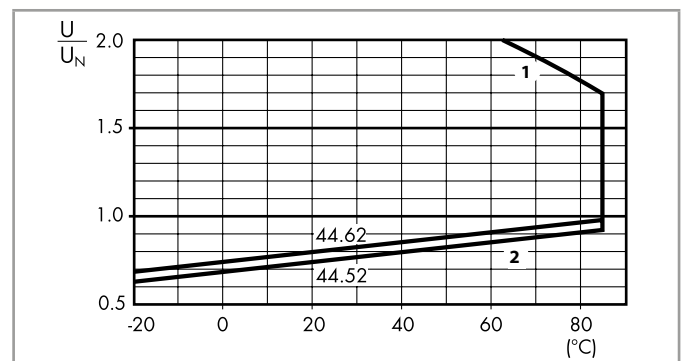

- 1 - Max. permitted coil voltage.
2 - Min. pick-up voltage with coil at ambient temperature.

A



95.P5

See page 5

Module	Socket	Relay	Description	Mounting	Accessories
99.02	95.P5	44.52 44.62	Push-in terminal sockets - For fast cable connection - Top terminals - Contacts - Bottom terminals - Coil	Panel or 35 mm rail (EN 60715) mount	- Coil indication and EMC suppression modules - Jumper link - Timer modules - Plastic retaining and release clip



95.05

See page 7

Module	Socket	Relay	Description	Mounting	Accessories
99.02	95.05	44.52 44.62	Screw terminal (Box clamp) socket - Top terminals - Contacts - Bottom terminals - Coil	Panel or 35 mm rail (EN 60715) mount	- Coil indication and EMC suppression modules - Jumper link - Timer modules - Plastic retaining and release clip



95.55

See page 8

Module	Socket	Relay	Description	Mounting	Accessories
99.02	95.55	44.52 44.62	Screwless terminal socket - For fast cable connections - Top terminals - Contacts - Bottom terminals - Coil	Panel or 35 mm rail (EN 60715) mount	- Coil indication and EMC suppression modules - Timer modules - Plastic retaining and release clip



95.85.3

See page 9

Module	Socket	Relay	Description	Mounting	Accessories
99.80	95.85.3	44.52 44.62	Screw terminal (Box clamp) socket	Panel or 35 mm rail (EN 60715) mount	- Coil indication and EMC suppression modules - Plastic retaining and release clip

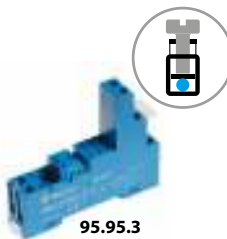

95.95.3

See page 10

Module	Socket	Relay	Description	Mounting	Accessories
99.80	95.95.3	44.52 44.62	Screw terminal (Box clamp) socket - Top terminals - Contacts - Bottom terminals - Coil	Panel or 35 mm rail (EN 60715) mount	- Coil indication and EMC suppression modules - Plastic retaining and release clip

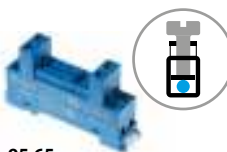

95.65

See page 11

Module	Socket	Relay	Description	Mounting	Accessories
—	95.65	44.52 44.62	Screw terminal (Box clamp) socket	Panel or 35 mm rail (EN 60715) mount	- Metal retaining clip



95.15.2

See page 12

Module	Socket	Relay	Description	Mounting	Accessories
—	95.15.2	44.52 44.62	PCB socket	PCB mounting	- Metal retaining clip

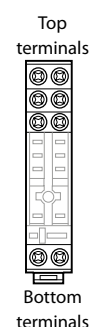
Top
terminals
Bottom
terminals



95.P5
Approvals
(according to type):
CE cRU[®]US
RINA



095.91.3

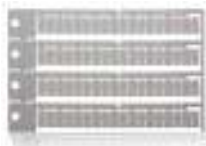

060.72

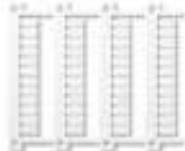

060.48

Push-in terminal socket panel or 35 mm rail mount	95.P5		
For relay type	44.52, 44.62		
Accessories			
Metal retaining clip	095.71		
Plastic retaining and release clip (supplied with socket - packaging code SPA)	095.91.3		
8-way jumper link	097.58		
2-way jumper link (12.5 mm pitch)	097.52		
2-way jumper link (4.6 mm pitch)	097.42		
Marker tag holder (for tags 060.48 and 060.72 types)	097.00		
Identification tag	095.00.4		
Modules (see table below)	99.02		
Timer modules (see table below)	86.30		
Sheet of marker tags for plastic retaining and release clip 095.91.3 and for marker tag holder 097.00, 48 tags, 6 x 12 mm, for CEMBRE's thermal transfert printer	060.48		
Sheet of marker tags for plastic retaining and release clip 095.91.3 and for marker tag holder 097.00, 72 tags, 6 x 12 mm, for plotter printing	060.72		
Technical data			
Rated values	10 A - 250 V		
Dielectric strength	6 kV (1.2/50 μ s) between coil and contacts		
Protection category	IP 20		
Ambient temperature	°C -40...+70 (see diagram L95)		
Wire strip length	mm	8	
Min. wire size for 95.P5 socket		solid wire	stranded wire
	mm ²	0.5	0.5
	AWG	21	21
Max. wire size for 95.P5 socket		solid wire	stranded wire
	mm ²	2 x 1.5 / 1 x 2.5	2 x 1.5 / 1 x 2.5
	AWG	2 x 18 / 1 x 14	2 x 18 / 1 x 14

L 95 - Total socket current vs ambient temperature

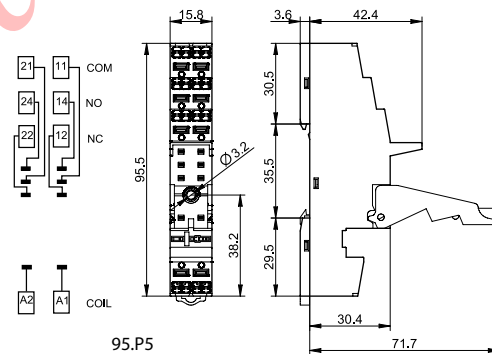
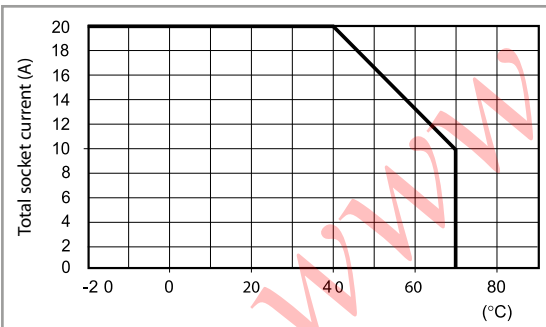

097.58

8-way jumper link for 95.P5 socket	097.58
Rated values	10 A - 250 V

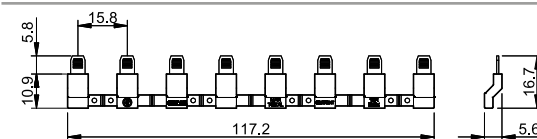

097.52

2-way jumper link for 95.P5 socket	097.52
Rated values	10 A - 250 V

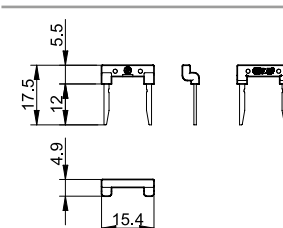

A



097.42

2-way jumper link for 95.P5 socket	097.42
Rated values	10 A - 250 V

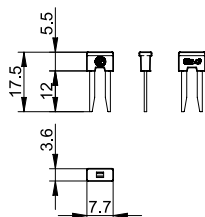



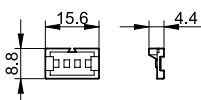

097.00

Marker tag holder for 95.P5 sockets	097.00
--	--------



86.30

86 series timer modules	
(12...24)V AC/DC; Bi-function: AI, DI; (0.05 s...100 h)	86.30.0.024.0000
(110...125)V AC; Bi-function: AI, DI; (0.05 s...100 h)	86.30.8.120.0000
(230...240)V AC; Bi-function: AI, DI; (0.05 s...100 h)	86.30.8.240.0000

Approvals (according to type):    

99.02

Approvals
(according to type):  DC Modules with
non-standard polarity
(+A2) on request.

99.02 coil indication and EMC suppression modules for 95.P5 socket		
Diode (+A1, standard polarity)	(6...220)V DC	99.02.3.000.00
LED	(6...24)V DC/AC	99.02.0.024.59
LED	(28...60)V DC/AC	99.02.0.060.59
LED	(110...240)V DC/AC	99.02.0.230.59
LED + Diode (+A1, standard polarity)	(6...24)V DC	99.02.9.024.99
LED + Diode (+A1, standard polarity)	(28...60)V DC	99.02.9.060.99
LED + Diode (+A1, standard polarity)	(110...220)V DC	99.02.9.220.99
LED + Varistor	(6...24)V DC/AC	99.02.0.024.98
LED + Varistor	(28...60)V DC/AC	99.02.0.060.98
LED + Varistor	(110...240)V DC/AC	99.02.0.230.98
RC circuit	(6...24)V DC/AC	99.02.0.024.09
RC circuit	(28...60)V DC/AC	99.02.0.060.09
RC circuit	(110...240)V DC/AC	99.02.0.230.09
Residual current by-pass	(110...240)V AC	99.02.8.230.07



95.05

Approvals (according to type):



UL US Certain relay/socket combinations



095.01



060.72

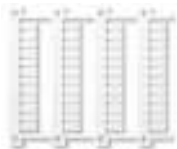

060.48



095.18



86.30



99.02

Approvals (according to type):



DC Modules with non-standard polarity (+A2) on request.

II-2016, www.findernet.com

Screw terminal (Box clamp) socket panel or 35 mm rail mount	95.05 (blue)	95.05.0 (black)	
For relay type	44.52, 44.62		
Accessories			
Metal retaining clip	095.71		
Plastic retaining and release clip (supplied with socket - packaging code SPA)	095.01	095.01.0	
8-way jumper link	095.18	095.18.0	
Marker tag holder (for tags 060.48 and 060.72 types)	097.00		
Identification tag	095.00.4		
Modules (see table below)	99.02		
Timer modules (see table below)	86.30		
Sheet of marker tags for plastic retaining and release clip 095.01 and for marker tag holder 097.00, 48 tags, 6 x 12 mm, for CEMBRE's thermal transfer printers	060.48		
Sheet of marker tags for plastic retaining and release clip 095.01 and for marker tag holder 097.00, 72 tags, 6 x 12 mm, for plotter printing	060.72		
Technical data			
Rated values	10 A - 250 V		
Dielectric strength	6 kV (1.2/50 μs) between coil and contacts		
Protection category	IP 20		
Ambient temperature	°C -40...+70 (see diagram L95)		
⊕ Screw torque	Nm	0.5	
Wire strip length	mm 8		
Max. wire size for 95.05 socket	solid wire	stranded wire	
	mm ²	1 x 6 / 2 x 2.5	1 x 4 / 2 x 2.5
	AWG	1 x 10 / 2 x 14	1 x 12 / 2 x 14

L 95 - Total socket current vs ambient temperature

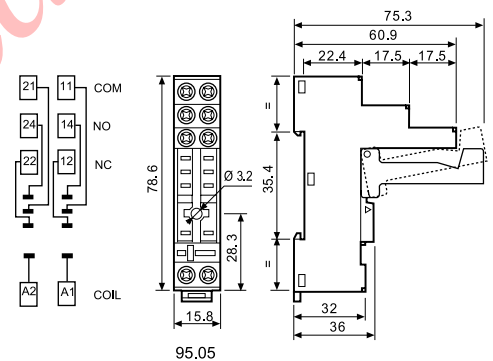
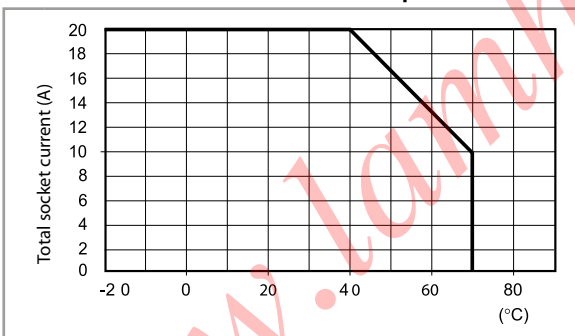

8-way jumper link for 95.05 socket	095.18 (blue)	095.18.0 (black)
Rated values	10 A - 250 V	

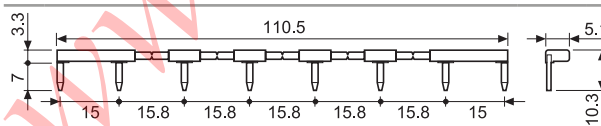

86 series timer modules		
(12...24)V AC/DC; Bi-function: AI, DI; (0.05 s...100 h)	86.30.0.024.0000	

Approvals (according to type):

99.02 coil indication and EMC suppression modules for 95.05 socket		
Diode (+A1, standard polarity)	(6...220)V DC	99.02.3.000.00
LED	(6...24)V DC/AC	99.02.0.024.59
LED	(28...60)V DC/AC	99.02.0.060.59
LED	(110...240)V DC/AC	99.02.0.230.59
LED + Diode (+A1, standard polarity)	(6...24)V DC	99.02.9.024.99
LED + Diode (+A1, standard polarity)	(28...60)V DC	99.02.9.060.99
LED + Diode (+A1, standard polarity)	(110...220)V DC	99.02.9.220.99
LED + Varistor	(6...24)V DC/AC	99.02.0.024.98
LED + Varistor	(28...60)V DC/AC	99.02.0.060.98
LED + Varistor	(110...240)V DC/AC	99.02.0.230.98
RC circuit	(6...24)V DC/AC	99.02.0.024.09
RC circuit	(28...60)V DC/AC	99.02.0.060.09
RC circuit	(110...240)V DC/AC	99.02.0.230.09
Residual current by-pass	(110...240)V AC	99.02.8.230.07

A



95.55

Approvals
(according to type):



095.91.3

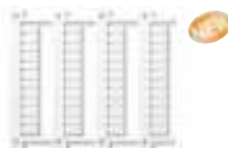

060.48

L 95 - Total socket current vs ambient temperature

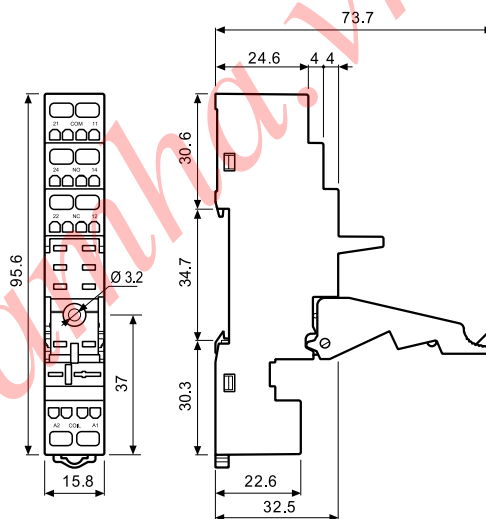
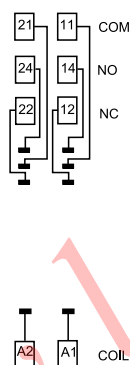
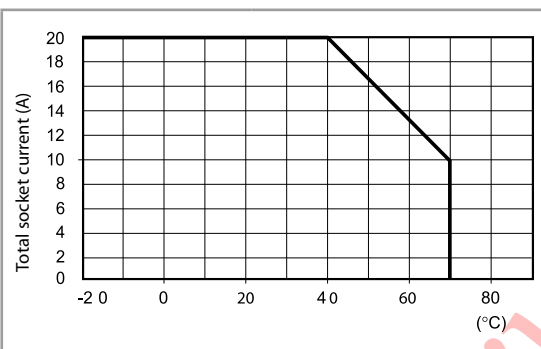

Screwless terminal socket panel or 35 mm rail mount	95.55 (blue)	95.55.0 (black)
For relay type	44.52, 44.62	
Accessories		
Metal retaining clip		095.71
Plastic retaining and release clip (supplied with socket - packaging code SPA)		095.91.3
Modules (see table below)		99.02
Timer modules (see table below)		86.30
Sheet of marker tags for plastic retaining and release clip 095.91.3, 48 tags, 6 x 12 mm, for CEMBRE's thermal transfer printers		060.48
Sheet of marker tags for retaining and release clip 095.91.3 plastic, 72 tags, 6 x 12 mm		060.72
Technical data		
Rated values	10 A - 250 V	
Dielectric strength	6 kV (1.2/50 µs) between coil and contacts	
Protection category	IP 20	
Ambient temperature	°C -25...+70 (see diagram L95)	
Wire strip length	mm 8	
Max. wire size for 95.55 socket	solid wire	stranded wire
	mm ² 2 x (0.2...1.5)	2 x (0.2...1.5)
	AWG 2 x (24...18)	2 x (24...18)



86.30

86 series timer modules	
(12...24)V AC/DC; Bi-function: AI, DI; (0.05 s...100 h)	86.30.0.024.0000

Approvals
(according to type):



99.02

Approvals
(according to type):



DC Modules with
non-standard polarity
(+A2) on request.

99.02 coil indication and EMC suppression modules for 95.55 socket		
Diode (+A1, standard polarity)	(6...220)V DC	99.02.3.000.00
LED	(6...24)V DC/AC	99.02.0.024.59
LED	(28...60)V DC/AC	99.02.0.060.59
LED	(110...240)V DC/AC	99.02.0.230.59
LED + Diode (+A1, standard polarity)	(6...24)V DC	99.02.9.024.99
LED + Diode (+A1, standard polarity)	(28...60)V DC	99.02.9.060.99
LED + Diode (+A1, standard polarity)	(110...220)V DC	99.02.9.220.99
LED + Varistor	(6...24)V DC/AC	99.02.0.024.98
LED + Varistor	(28...60)V DC/AC	99.02.0.060.98
LED + Varistor	(110...240)V DC/AC	99.02.0.230.98
RC circuit	(6...24)V DC/AC	99.02.0.024.09
RC circuit	(28...60)V DC/AC	99.02.0.060.09
RC circuit	(110...240)V DC/AC	99.02.0.230.09
Residual current by-pass	(110...240)V AC	99.02.8.230.07

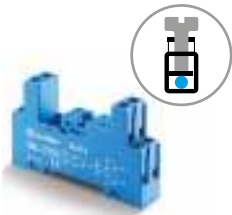

95.85.3

Approvals
(according to type):



95.91.3

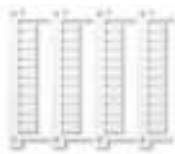

060.48

Screw terminal (Box clamp) socket panel or 35 mm rail mount	95.85.3 (blue)	95.85.30 (black)	
For relay type	44.52, 44.62		
Accessories			
Metal retaining clip	095.71		
Plastic retaining and release clip (supplied with socket - packaging code SPA)	095.91.3	095.91.30	
8-way jumper link	095.08	095.08.0	
Identification tag	095.00.4		
Modules (see table below)	99.80		
Sheet of marker tags for plastic retaining and release clip 095.91.3, 48 tags, 6 x 12 mm, for CEMBRE's thermal transfert printer	060.48		
Sheet of marker tags for retaining and release clip 095.91.3 plastic, 72 tags, 6 x 12 mm	060.72		
Technical data			
Rated values	10 A - 250 V		
Dielectric strength	6 kV (1.2/50 μs) between coil and contacts		
Protection category	IP 20		
Ambient temperature	°C -40...+70 (see diagram L95)		
Screw torque	Nm	0.5	
Wire strip length	mm 7		
Max. wire size for 95.85.3 socket	solid wire	stranded wire	
	mm ²	1 x 6 / 2 x 2.5	1 x 4 / 2 x 2.5
	AWG	1 x 10 / 2 x 14	1 x 12 / 2 x 14

L 95 - Total socket current vs ambient temperature

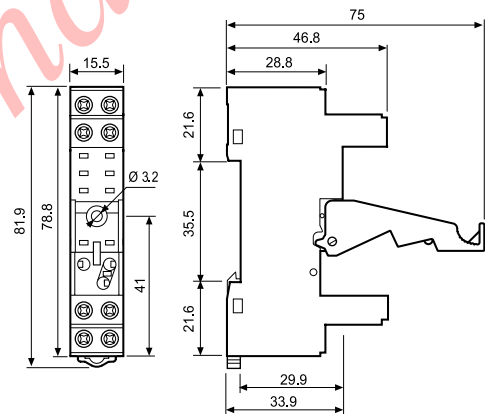
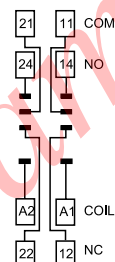
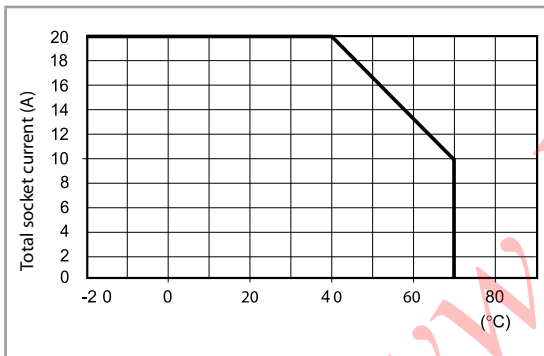

95.08



8-way jumper link for 95.85.3 socket	095.08 (blue)	095.08.0 (black)
Rated values	10 A - 250 V	

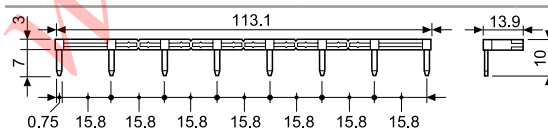

99.80

Approvals
(according to type):



99.80 coil indication and EMC suppression modules for 95.85.3 socket	Blue*
Diode (+A1, standard polarity)	(6...220)V DC 99.80.3.000.00
LED	(6...24)V DC/AC 99.80.0.024.59
LED	(28...60)V DC/AC 99.80.0.060.59
LED	(110...240)V DC/AC 99.80.0.230.59
LED + Diode (+A1, standard polarity)	(6...24)V DC 99.80.9.024.99
LED + Diode (+A1, standard polarity)	(28...60)V DC 99.80.9.060.99
LED + Diode (+A1, standard polarity)	(110...220)V DC 99.80.9.220.99
LED + Varistor	(6...24)V DC/AC 99.80.0.024.98
LED + Varistor	(28...60)V DC/AC 99.80.0.060.98
LED + Varistor	(110...240)V DC/AC 99.80.0.230.98
RC circuit	(6...24)V DC/AC 99.80.0.024.09
RC circuit	(28...60)V DC/AC 99.80.0.060.09
RC circuit	(110...240)V DC/AC 99.80.0.230.09
Residual current by-pass	(110...240)V AC 99.80.8.230.07

* Modules in Black housing are available on request.
Green LED is standard.
Red LED available on request.

A



095.95.3

Approvals
(according to type):



095.91.3

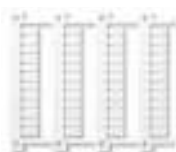

060.48

Screw terminal (Box clamp) socket panel or 35 mm rail mount	95.95.3 (blue)	95.95.30 (black)
For relay type	44.52, 44.62	
Accessories		
Metal retaining clip	095.71	
Plastic retaining and release clip (supplied with socket - packaging code SPA)	095.91.3	095.91.30
8-way jumper link	095.08	095.08.0
Identification tag	095.00.4	
Modules (see table below)	99.80	
Sheet of marker tags for plastic retaining and release clip 095.91.3 and for marker tag holder 097.00, 48 tags, 6 x 12 mm, for CEMBRE's thermal transfer printers	060.48	
Sheet of marker tags for retaining and release clip 095.91.3 plastic, 72 tags, 6 x 12 mm	060.72	
Technical data		
Rated values	10 A - 250 V	
Dielectric strength	6 kV (1.2/50 μs) between coil and contacts	
Protection category	IP 20	
Ambient temperature	°C -40...+70 (see diagram L95)	
Screw torque	Nm	0.5
Wire strip length	mm	8
Max. wire size for 95.95.3 socket	solid wire	stranded wire
	mm ²	1 x 6 / 2 x 2.5
	AWG	1 x 10 / 2 x 14

L 95 - Total socket current vs ambient temperature

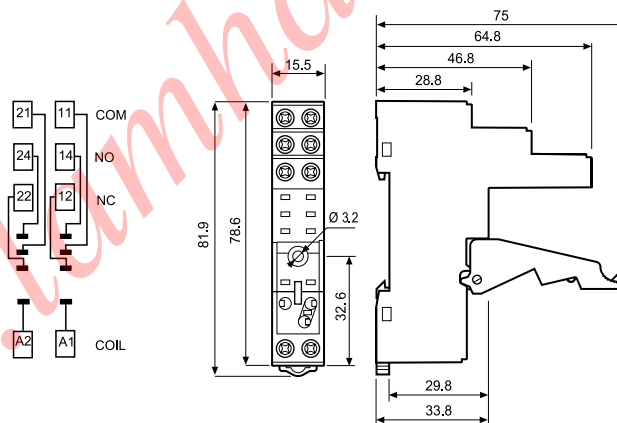
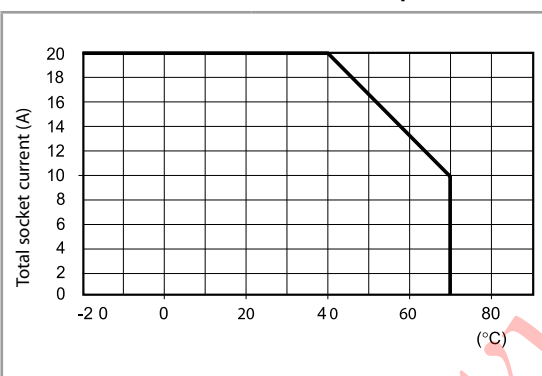

095.08

8-way jumper link for 95.95.3 socket	095.08 (blue)	095.08.0 (black)
Rated values	10 A - 250 V	



99.80

Approvals
(according to type):



* Modules in Black housing are available on request.
Green LED is standard.
Red LED available on request.

99.80 coil indication and EMC suppression modules for 95.95.3 socket		Blue*
Diode (+A1, standard polarity)	(6...220)V DC	99.80.3.000.00
LED	(6...24)V DC/AC	99.80.0.024.59
LED	(28...60)V DC/AC	99.80.0.060.59
LED	(110...240)V DC/AC	99.80.0.230.59
LED + Diode (+A1, standard polarity)	(6...24)V DC	99.80.9.024.99
LED + Diode (+A1, standard polarity)	(28...60)V DC	99.80.9.060.99
LED + Diode (+A1, standard polarity)	(110...220)V DC	99.80.9.220.99
LED + Varistor	(6...24)V DC/AC	99.80.0.024.98
LED + Varistor	(28...60)V DC/AC	99.80.0.060.98
LED + Varistor	(110...240)V DC/AC	99.80.0.230.98
RC circuit	(6...24)V DC/AC	99.80.0.024.09
RC circuit	(28...60)V DC/AC	99.80.0.060.09
RC circuit	(110...240)V DC/AC	99.80.0.230.09
Residual current by-pass	(110...240)V AC	99.80.8.230.07



95.65

Approvals
(according to type):



Screw terminal (Box clamp) socket panel or 35 mm rail mount	95.65 (blue)	
For relay type	44.52, 44.62	
Accessories		
Metal retaining clip	095.71	
8-way jumper link	095.08	
Modules	—	
Technical data		
Rated values	10 A - 250 V	
Dielectric strength	2 kV AC	
Protection category	IP 20	
Ambient temperature	°C -40...+70 (see diagram L95)	
Screw torque	Nm	0.5
Wire strip length	mm	7
Max. wire size for 95.65 socket	solid wire	stranded wire
	mm ²	1 x 6 / 2 x 2.5
	AWG	1 x 10 / 2 x 14

L 95 - Total socket current vs ambient temperature

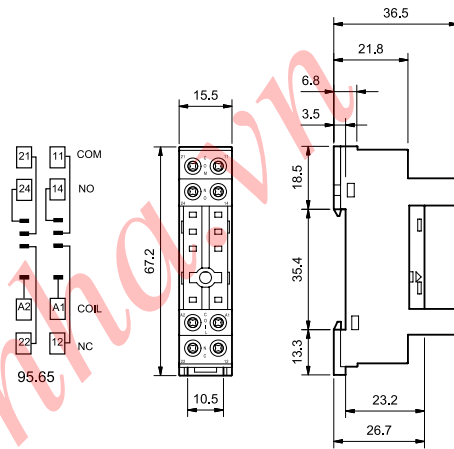
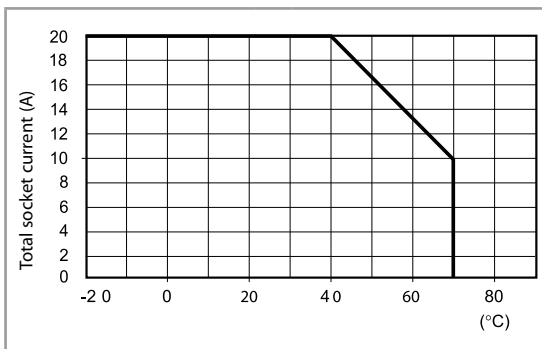

095.08



8-way jumper link for 95.65 socket	095.08 (blue)
Rated values	10 A - 250 V



A

95.15.2

Approvals
(according to type):



PCB socket	95.15.2 (blue)	95.15.20 (black)
For relay type	44.52, 44.62	
Accessories		
Metal retaining clip (supplied with socket - packaging code SMA)		095.51
Plastic retaining clip		095.52
Technical data		
Rated values	10 A - 250 V	
Dielectric strength	6 kV (1.2/50 μs) between coil and contacts	
Protection category	IP 20	
Ambient temperature	°C -40...+70	

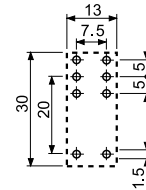
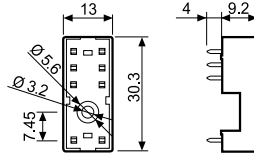
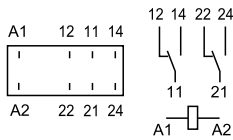

Copper side view

www.lamha.vn

Packaging codes

How to code and identify retaining clip and packaging options for sockets.

Example:



A Standard packaging

SM Metal retaining clip
SP Plastic retaining clip