



Catalog

AX contactor range

Control made simple
The performance you need

Motor rated operational powers and currents

The currents given below concern standard three-phase four-pole cage motors (1500 r.p.m. at 50 Hz 1800 r.p.m. at 60 Hz). These values are given for guidance and may vary according to the motor manufacturer and depending on the number of poles.

IEC Motor power kW	Motor nominal current: standardized values in blue colour (according to IEC 60947-4-1 Annex G)									
	220 V A	230 V A	240 V A	380 V A	400 V A	415 V A	440 V A	500 V A	660 V A	690 V A
0.06	0.37	0.35	0.34	0.21	0.2	0.19	0.18	0.16	0.13	0.12
0.09	0.54	0.52	0.50	0.32	0.3	0.29	0.26	0.24	0.18	0.17
0.12	0.73	0.7	0.67	0.46	0.44	0.42	0.39	0.32	0.24	0.23
0.18	1	1	1	0.63	0.6	0.58	0.53	0.48	0.37	0.35
0.25	1.6	1.5	1.4	0.9	0.85	0.82	0.74	0.68	0.51	0.49
0.37	2.0	1.9	1.8	1.2	1.1	1.1	1	0.88	0.67	0.64
0.55	2.7	2.6	2.5	1.6	1.5	1.4	1.3	1.2	0.91	0.87
0.75	3.5	3.3	3.2	2.0	1.9	1.8	1.7	1.5	1.15	1.1
1.1	4.9	4.7	4.5	2.8	2.7	2.6	2.4	2.2	1.7	1.6
1.5	6.6	6.3	6	3.8	3.6	3.5	3.2	2.9	2.2	2.1
2.2	8.9	8.5	8.1	5.2	4.9	4.7	4.3	3.9	2.9	2.8
3	11.8	11.3	10.8	6.8	6.5	6.3	5.7	5.2	4	3.8
4	15.7	15	14.4	8.9	8.5	8.2	7.4	6.8	5.1	4.9
5.5	20.9	20	19.2	12.1	11.5	11.1	10.1	9.2	7	6.7
7.5	28.2	27	25.9	16.3	15.5	14.9	13.6	12.4	9.3	8.9
11	39.7	38	36.4	23.2	22	21.2	19.3	17.6	13.4	12.8
15	53.3	51	48.9	30.5	29	28	25.4	23	17.8	17
18.5	63.8	61	58.5	36.8	35	33.7	30.7	28	22	21
22	75.3	72	69	43.2	41	39.5	35.9	33	25.1	24
30	100	96	92	57.9	55	53	48.2	44	33.5	32
37	120	115	110	69	66	64	58	53	40.8	39
45	146	140	134	84	80	77	70	64	49.1	47
55	177	169	162	102	97	93	85	78	59.6	57
75	240	230	220	139	132	127	116	106	81	77
90	291	278	266	168	160	154	140	128	97	93
110	355	340	326	205	195	188	171	156	118	113
132	418	400	383	242	230	222	202	184	140	134
160	509	487	467	295	280	270	245	224	169	162
200	637	609	584	368	350	337	307	280	212	203
250	782	748	717	453	430	414	377	344	261	250
315	983	940	901	568	540	520	473	432	327	313
355	1109	1061	1017	642	610	588	535	488	370	354
400	1255	1200	1150	726	690	665	605	552	418	400
500	1545	1478	1416	895	850	819	745	680	515	493
560	1727	1652	1583	1000	950	916	832	760	576	551
630	1928	1844	1767	1116	1060	1022	929	848	643	615
710	2164	2070	1984	1253	1190	1147	1043	952	721	690
800	2446	2340	2243	1417	1346	1297	1179	1076	815	780
900	2760	2640	2530	1598	1518	1463	1330	1214	920	880
1000	3042	2910	2789	1761	1673	1613	1466	1339	1014	970

Motor protection and control

Contactors, manual motor starters and overload relays

Overview	1
AX contactors and NX contactor relays	2
Manual motor starters	3
Overload relays	4
General technical data	5
Index	6

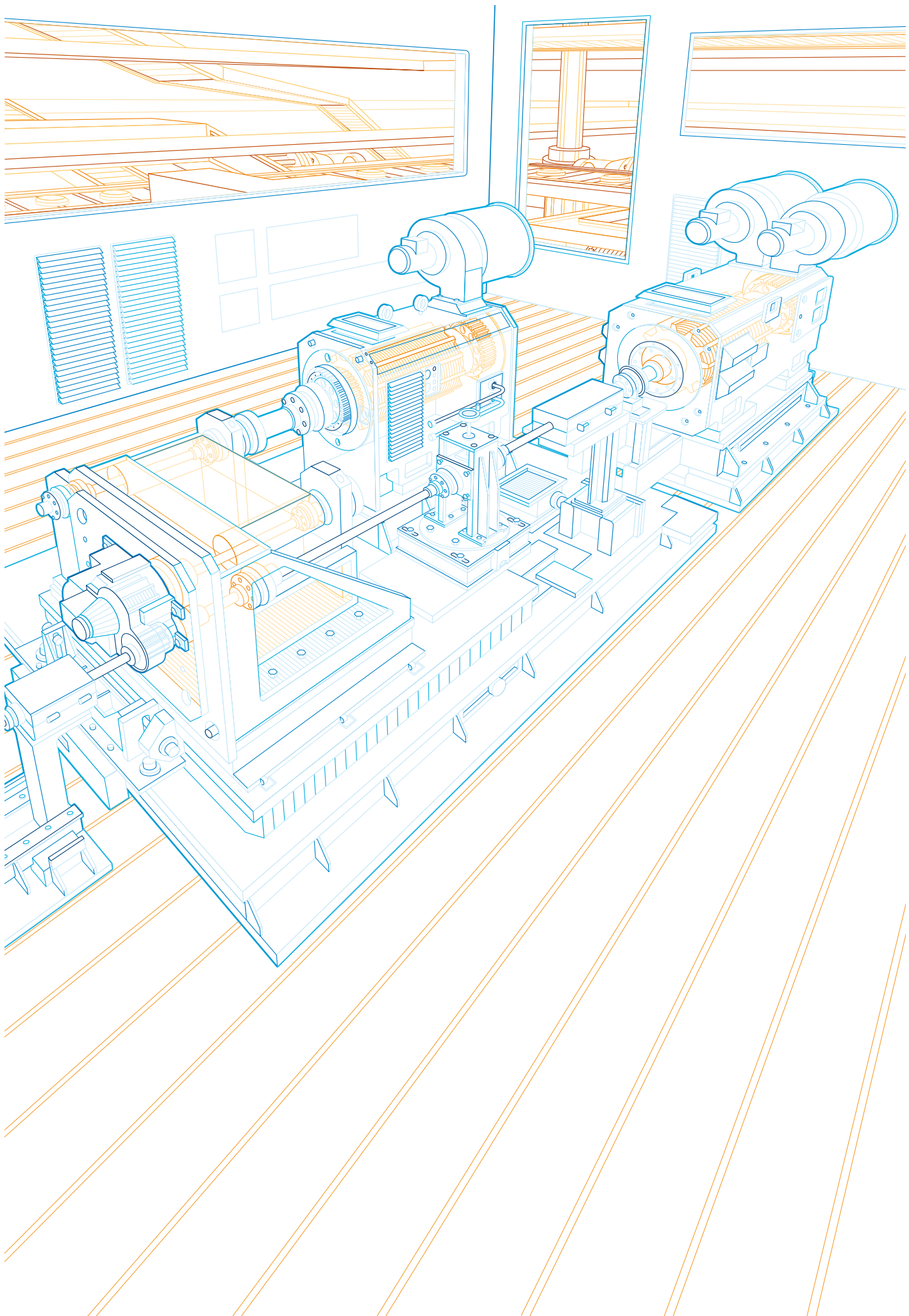

AX contactor range

Control made simple – The performance you need

The AX contactor range offer reliable performance, in a compact and modern design

1



Technical data

- Rated operational current (Ie): 9...370 A (400 V AC-3)
- Motor rated operational power: 4...200 kW (400 V AC-3)
- AC control supply
- Width from 44 mm (9 A) to 145 mm (370 A)
- Ambient temperature up to 70 °C.

Accessories

- Auxiliary contacts front- and side-mounted
- Mechanical and electrical interlocks
- Timers
- Surge suppressors
- Terminal shrouds, enlargements and extensions
- Connection kits
- Thermal and electronic overload relays.

Certifications



Manual motor starters

- With thermal and magnetic protection
- With magnetic protection only.

Common applications :

HVAC, pumps, compressors, paper industry, mining, general machinery, switchgear panels, elevator and escalators, building, etc.



1SYN829571C0201

3-pole contactors for motor control and power switching

1





IEC	AC-3 Rated operational power	$\theta \leq 55^\circ\text{C}, 400\text{ V}$	kW
AC Control supply			Type
IEC	AC-3 Rated operational current	$\theta \leq 55^\circ\text{C}, 400\text{ V}$	A
	AC-1 Rated operational current	$\theta \leq 40^\circ\text{C}, 690\text{ V}$	A

4	5.5	7.5	11	15	18.5
AX09	AX12	AX18	AX25	AX32	AX40
9	12	18	25	32	40
22	25	27	32	55	60

Main accessories

Auxiliary contact blocks	Front mounting	CA5X-10 (1 x N.O.) CA5X-01 (1 x N.C.) CA5X-4 pole (add on block with 4 contacts N.O. or N.C. combination)
	Side mounting	CAL5X-11 (1 x N.O. + 1 x N.C.)
Timers	Electronic	TEF5-ON TEF5-OFF
	Mechanical	VM5-1
Interlocking units	Mechanical / Electrical	VE5-1
	Varistor (AC / DC)	RV5 (24...440 V)
Surge suppressors	RC type (AC)	RC5-1 (24...440 V)

Overload relays

Thermal relays	Class 10A		TA25DU-M (0.10...32 A) (1)	TA42DU-M (18...42 A)
			E16DU (0.10...18.9 A)	E45DU (9...45 A)
Electronic relays	Class 10E, 20E, 30E			

- (1) The max. AC-3 operational current is 23 A for AX25 with TA25DU-25M
- (2) The max. AC-3 operational current is 74 A for AX80 with TA75DU-80M
- (3) The max. AC-3 operational current is 182 A for AX205 with TA200DU-200.

Manual motor starters

	Thermal / magnetic protection Class 10	MS116 (0.10...32 A) lcs up to 50 kA for class 10A	MS450 (28...50 A) lcs up to 50 kA
		MS132 (0.10...32 A) lcs up to 100 kA	MS497 (22...100 A) lcs up to 100 kA
	Magnetic types only	MO132 (0.16...32 A) lcs up to 100 kA	MO496 (32...100 A) lcs up to 100 kA
			MO450 (40...50 A) lcs up to 50 kA
Accessories	For contactor mounting	BEA16/116 (4)	BEA25/116 (4) BEA25/132 (5)
			BEA40/450 For MS450

- (4) AX.. with MS116-0.16 ... MS116-16 or MS132-0.16 ... MS132-10
- (5) AX25 with MS116-20 ... MS116-32 or MS132-12 ... MS132-32.

1SYN829571C0201



	22	30	37	45	55	75	90	110	132	160	200
	AX50	AX65	AX80	AX95	AX115	AX150	AX185	AX205	AX260	AX300	AX370
	50	65	80	96	115	150	185	205	265	305	370
	100	115	125	145	160	190	250	275	400	500	600

				CAL18X-11 (1 x N.O. + 1 x N.C.)				CAL19-11 (1 x N.O. + 1 x N.C.)				
							VM300H			VM19		
	VE5-2											
	RC5-2 (24...440 V)						RC5-3 (250...440 V)					

	TA75DU-M (18...80 A) (2)	TA80DU (29...80 A)	TA200DU (66...200 A) (3)	
		TA110DU (66...110 A)		
	E80DU (27...80 A)	E140DU (50...140 A)	EF205 (63...210 A)	EF370 (115...380 A)

Short-circuit protection devices

MCCB and switch fuses

	MS495 (45...100 A) lcs up to 50 kA		
		MO495 (63...100 A) lcs up to 50 kA	
	BEA50/450 For MS450	BEA100/495 For MS495	
	BEA75/495 For MS495		





AX contactors and NX contactor relays

AX 3-pole contactors

Ordering details 3-pole contactors	2/3
Main accessories	2/10
Technical data 3-pole contactors	2/16
Terminal marking and positioning	2/27
Dimensions	2/28

NX contactor relays

Ordering details	2/34
Main accessories	2/35
Technical data	2/36
Terminal marking and positioning	2/38

Accessories for AX contactors and NX contactor relays

Voltage code table

General technical data

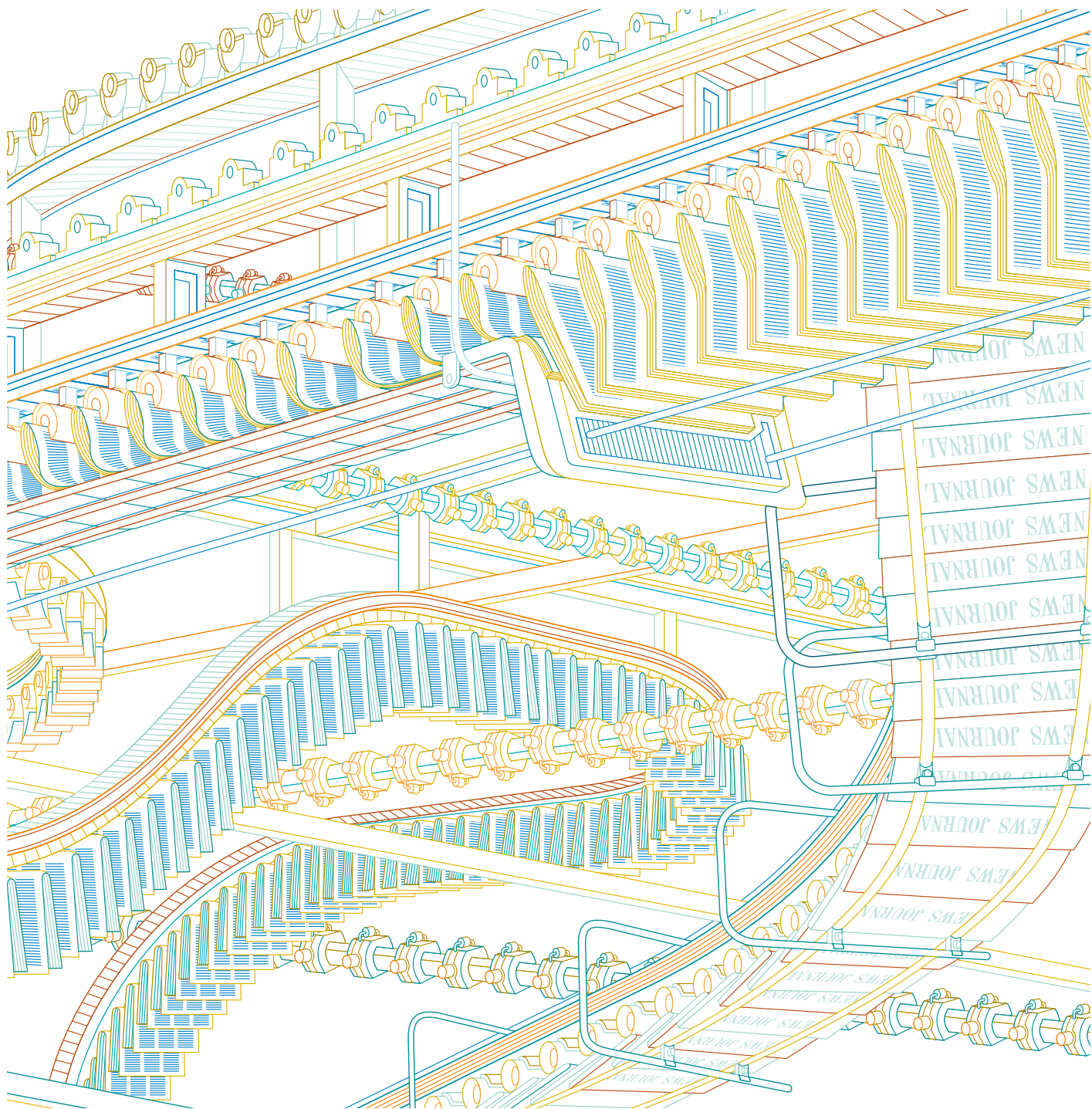

AX09 ... AX25 3-pole contactors

4 to 11 kW

AC operated



AX09 ... AX25

Description

AX09 ... AX25 contactors are mainly used for controlling 3-phase motors and power circuits up to 690 V AC.

These contactors are of the block type design with:

- 3 main poles and 1 built-in auxiliary contact
- control circuit: AC operated
- add-on auxiliary contact blocks for front or side mounting and a wide range of accessories.

Ordering details

IEC		Rated control circuit voltage		Auxiliary contacts fitted	Type	Order code	Weight		
Rated power	operational current	U _c (1)						Pkg (1 pce)	
400 V	θ ≤ 40 °C	V 50 Hz	V 60 Hz				kg		
AC-3	AC-1								
kW	A								
4	22	24	24	1 0	AX09-30-10-81	1SBL901074R8110	0.340		
				0 1	AX09-30-01-81	1SBL901074R8101	0.340		
		110	110...120	1 0	AX09-30-10-84	1SBL901074R8410	0.340		
				0 1	AX09-30-01-84	1SBL901074R8401	0.340		
		220...230	230...240	1 0	AX09-30-10-80	1SBL901074R8010	0.340		
				0 1	AX09-30-01-80	1SBL901074R8001	0.340		
		230...240	240...260	1 0	AX09-30-10-88	1SBL901074R8810	0.340		
				0 1	AX09-30-01-88	1SBL901074R8801	0.340		
		400...415	415...440	1 0	AX09-30-10-86	1SBL901074R8610	0.340		
				0 1	AX09-30-01-86	1SBL901074R8601	0.340		
		5.5	25	24	24	1 0	AX12-30-10-81	1SBL911074R8110	0.340
						0 1	AX12-30-01-81	1SBL911074R8101	0.340
110	110...120			1 0	AX12-30-10-84	1SBL911074R8410	0.340		
				0 1	AX12-30-01-84	1SBL911074R8401	0.340		
220...230	230...240			1 0	AX12-30-10-80	1SBL911074R8010	0.340		
				0 1	AX12-30-01-80	1SBL911074R8001	0.340		
230...240	240...260			1 0	AX12-30-10-88	1SBL911074R8810	0.340		
				0 1	AX12-30-01-88	1SBL911074R8801	0.340		
400...415	415...440			1 0	AX12-30-10-86	1SBL911074R8610	0.340		
				0 1	AX12-30-01-86	1SBL911074R8601	0.340		
7.5	27			24	24	1 0	AX18-30-10-81	1SBL921074R8110	0.340
						0 1	AX18-30-01-81	1SBL921074R8101	0.340
		110	110...120	1 0	AX18-30-10-84	1SBL921074R8410	0.340		
				0 1	AX18-30-01-84	1SBL921074R8401	0.340		
		220...230	230...240	1 0	AX18-30-10-80	1SBL921074R8010	0.340		
				0 1	AX18-30-01-80	1SBL921074R8001	0.340		
		230...240	240...260	1 0	AX18-30-10-88	1SBL921074R8810	0.340		
				0 1	AX18-30-01-88	1SBL921074R8801	0.340		
		400...415	415...440	1 0	AX18-30-10-86	1SBL921074R8610	0.340		
				0 1	AX18-30-01-86	1SBL921074R8601	0.340		
		11	32	24	24	1 0	AX25-30-10-81	1SBL931074R8110	0.340
						0 1	AX25-30-01-81	1SBL931074R8101	0.340
110	110...120			1 0	AX25-30-10-84	1SBL931074R8410	0.340		
				0 1	AX25-30-01-84	1SBL931074R8401	0.340		
220...230	230...240			1 0	AX25-30-10-80	1SBL931074R8010	0.340		
				0 1	AX25-30-01-80	1SBL931074R8001	0.340		
230...240	240...260			1 0	AX25-30-10-88	1SBL931074R8810	0.340		
				0 1	AX25-30-01-88	1SBL931074R8801	0.340		
400...415	415...440			1 0	AX25-30-10-86	1SBL931074R8610	0.340		
				0 1	AX25-30-01-86	1SBL931074R8601	0.340		

(1) for other voltage version see page no. 2/51

AX32, AX40 3-pole contactors

15 to 18.5 kW

AC operated

2



AX32, AX40

Description

AX32, AX40 contactors are mainly used for controlling 3-phase motors and power circuits up to 690 V AC.

These contactors are of the block type design with:

- 3 main poles and 1 built-in auxiliary contact
- control circuit: AC operated
- add-on auxiliary contact blocks for front or side mounting and a wide range of accessories.

Ordering details

IEC Rated operational power 400 V AC-3 kW	Rated operational current $\theta \leq 40^\circ\text{C}$ AC-1 A	Rated control circuit voltage Uc (1)		Auxiliary contacts fitted 	Type	Order code	Weight Pkg (1 pce) kg
		V 50 Hz	V 60 Hz				
15	55	24	24	1 0	AX32-30-10-81	1SBL281074R8110	0.71
				0 1	AX32-30-01-81	1SBL281074R8101	0.71
		110	110...120	1 0	AX32-30-10-84	1SBL281074R8410	0.71
				0 1	AX32-30-01-84	1SBL281074R8401	0.71
		220...230	230...240	1 0	AX32-30-10-80	1SBL281074R8010	0.71
				0 1	AX32-30-01-80	1SBL281074R8001	0.71
		230...240	240...260	1 0	AX32-30-10-88	1SBL281074R8810	0.71
				0 1	AX32-30-01-88	1SBL281074R8801	0.71
		400...415	415...440	1 0	AX32-30-10-86	1SBL281074R8610	0.71
				0 1	AX32-30-01-86	1SBL281074R8601	0.71
18.5	60	24	24	1 0	AX40-30-10-81	1SBL321074R8110	0.71
				0 1	AX40-30-01-81	1SBL321074R8101	0.71
		110	110...120	1 0	AX40-30-10-84	1SBL321074R8410	0.71
				0 1	AX40-30-01-84	1SBL321074R8401	0.71
		220...230	230...240	1 0	AX40-30-10-80	1SBL321074R8010	0.71
				0 1	AX40-30-01-80	1SBL321074R8001	0.71
		230...240	240...260	1 0	AX40-30-10-88	1SBL321074R8810	0.71
				0 1	AX40-30-01-88	1SBL321074R8801	0.71
		400...415	415...440	1 0	AX40-30-10-86	1SBL321074R8610	0.71
				0 1	AX40-30-01-86	1SBL321074R8601	0.71

(1) for other voltage version see page no. 2/51

AX50 ... AX80 3-pole contactors

22 to 37 kW

AC operated



AX50 ... AX80

Description

AX50 ... AX80 contactors are mainly used for controlling 3-phase motors and power circuits up to 690 V AC.

These contactors are of the block type design with:

- 3 main poles
- control circuit: AC operated
- add-on auxiliary contact blocks for front or side mounting and a wide range of accessories.

Ordering details (without auxiliary block)

IEC Rated operational power 400 V AC-3 kW	Rated operational current $\theta \leq 40\text{ }^\circ\text{C}$ AC-1 A	Rated control circuit voltage Uc (1)		Auxiliary contacts fitted Y Y	Type	Order code	Weight Pkg (1 pce) kg
		V 50 Hz	V 60 Hz				
22	100	24	24	0 0	AX50-30-00-81	1SBL351074R8100	1.12
		110	110...120	0 0	AX50-30-00-84	1SBL351074R8400	1.12
		220...230	230...240	0 0	AX50-30-00-80	1SBL351074R8000	1.12
		230...240	240...260	0 0	AX50-30-00-88	1SBL351074R8800	1.12
		400...415	415...440	0 0	AX50-30-00-86	1SBL351074R8600	1.12
30	115	24	24	0 0	AX65-30-00-81	1SBL371074R8100	1.12
		110	110...120	0 0	AX65-30-00-84	1SBL371074R8400	1.12
		220...230	230...240	0 0	AX65-30-00-80	1SBL371074R8000	1.12
		230...240	240...260	0 0	AX65-30-00-88	1SBL371074R8800	1.12
		400...415	415...440	0 0	AX65-30-00-86	1SBL371074R8600	1.12
37	125	24	24	0 0	AX80-30-00-81	1SBL411074R8100	1.12
		110	110...120	0 0	AX80-30-00-84	1SBL411074R8400	1.12
		220...230	230...240	0 0	AX80-30-00-80	1SBL411074R8000	1.12
		230...240	240...260	0 0	AX80-30-00-88	1SBL411074R8800	1.12
		400...415	415...440	0 0	AX80-30-00-86	1SBL411074R8600	1.12

(1) for other voltage version see page no. 2/51

AX50 ... AX80 3-pole contactors

22 to 37 kW

AC operated

2



AX50 ... AX80

Description

AX50 ... AX80 contactors are mainly used for controlling 3-phase motors and power circuits up to 690 V AC.

These contactors are of the block type design with:

- 3 main poles and side mounted auxiliary contact block
- control circuit: AC operated
- add-on auxiliary contact blocks for front or side mounting and a wide range of accessories.

Ordering details

IEC Rated operational power 400 V AC-3 kW	Rated operational current $\theta \leq 40\text{ }^\circ\text{C}$ AC-1 A	Rated control circuit voltage U_c (1)		Auxiliary contacts fitted Y Y	Type	Order code	Weight Pkg (1 pce) kg
		V 50 Hz	V 60 Hz				
22	100	24	24	1 1	AX50-30-11-81	1SBL351074R8111	1.16
		110	110...120	1 1	AX50-30-11-84	1SBL351074R8411	1.16
		220...230	230...240	1 1	AX50-30-11-80	1SBL351074R8011	1.16
		230...240	240...260	1 1	AX50-30-11-88	1SBL351074R8811	1.16
		400...415	415...440	1 1	AX50-30-11-86	1SBL351074R8611	1.16
30	115	24	24	1 1	AX65-30-11-81	1SBL371074R8111	1.16
		110	110...120	1 1	AX65-30-11-84	1SBL371074R8411	1.16
		220...230	230...240	1 1	AX65-30-11-80	1SBL371074R8011	1.16
		230...240	240...260	1 1	AX65-30-11-88	1SBL371074R8811	1.16
		400...415	415...440	1 1	AX65-30-11-86	1SBL371074R8611	1.16
37	125	24	24	1 1	AX80-30-11-81	1SBL411074R8111	1.16
		110	110...120	1 1	AX80-30-11-84	1SBL411074R8411	1.16
		220...230	230...240	1 1	AX80-30-11-80	1SBL411074R8011	1.16
		230...240	240...260	1 1	AX80-30-11-88	1SBL411074R8811	1.16
		400...415	415...440	1 1	AX80-30-11-86	1SBL411074R8611	1.16

(1) for other voltage version see page no. 2/51

AX95 ... AX150 3-pole contactors

45 to 75 kW

AC operated



AX95 ... AX150

Description

AX95 ... AX150 contactors are mainly used for controlling 3-phase motors and power circuits up to 690 V AC.

These contactors are of the block type design with:

- 3 main poles and side mounted auxiliary contact block
- control circuit: AC operated
- add-on auxiliary contact blocks for front or side mounting and a wide range of accessories.

Ordering details

IEC Rated operational power 400 V AC-3 kW	Rated operational current $\theta \leq 40 \text{ }^\circ\text{C}$ AC-1 A	Rated control circuit voltage Uc (1)		Auxiliary contacts fitted 	Type	Order code	Weight Pkg (1 pce) kg
		V 50 Hz	V 60 Hz				
45	145	24	24	1 1	AX95-30-11-81	1SFL431074R8111	2.08
		110	110...120	1 1	AX95-30-11-84	1SFL431074R8411	2.08
		220...230	230...240	1 1	AX95-30-11-80	1SFL431074R8011	2.08
		230...240	240...260	1 1	AX95-30-11-88	1SFL431074R8811	2.08
		400...415	415...440	1 1	AX95-30-11-86	1SFL431074R8611	2.08
55	160	24	24	1 1	AX115-30-11-81	1SFL981074R8111	2.08
		110	110...120	1 1	AX115-30-11-84	1SFL981074R8411	2.08
		220...230	230...240	1 1	AX115-30-11-80	1SFL981074R8011	2.08
		230...240	240...260	1 1	AX115-30-11-88	1SFL981074R8811	2.08
		400...415	415...440	1 1	AX115-30-11-86	1SFL981074R8611	2.08
75	190	24	24	1 1	AX150-30-11-81	1SFL991074R8111	2.08
		110	110...120	1 1	AX150-30-11-84	1SFL991074R8411	2.08
		220...230	230...240	1 1	AX150-30-11-80	1SFL991074R8011	2.08
		230...240	240...260	1 1	AX150-30-11-88	1SFL991074R8811	2.08
		400...415	415...440	1 1	AX150-30-11-86	1SFL991074R8611	2.08

(1) for other voltage version see page no. 2/51

AX185, AX205 3-pole contactors

90 to 110 kW

AC operated

2



AX185, AX205

Description

AX185, AX205 contactors are mainly used for controlling 3-phase motors and power circuits up to 690 V AC.

These contactors are of the block type design with:

- 3 main poles and side mounted auxiliary contact block
- control circuit: AC operated
- add-on auxiliary contact blocks for side mounting and a wide range of accessories.

Ordering details

IEC	Rated operational power 400 V AC-3 kW	Rated operational current $\theta \leq 40^\circ\text{C}$ AC-1 A	Rated control circuit voltage Uc (1)		Auxiliary contacts fitted	Type	Order code	Weight Pkg (1 pce) kg
			V 50 Hz	V 60 Hz				
90	250		24	24	1 1	AX185-30-11-81	1SFL491074R8111	3.80
			110	110...120	1 1	AX185-30-11-84	1SFL491074R8411	3.80
			220...230	230...240	1 1	AX185-30-11-80	1SFL491074R8011	3.80
			230...240	240...260	1 1	AX185-30-11-88	1SFL491074R8811	3.80
			400...415	415...440	1 1	AX185-30-11-86	1SFL491074R8611	3.80
110	275		24	24	1 1	AX205-30-11-81	1SFL501074R8111	3.80
			110	110...120	1 1	AX205-30-11-84	1SFL501074R8411	3.80
			220...230	230...240	1 1	AX205-30-11-80	1SFL501074R8011	3.80
			230...240	240...260	1 1	AX205-30-11-88	1SFL501074R8811	3.80
			400...415	415...440	1 1	AX205-30-11-86	1SFL501074R8611	3.80

(1) for other voltage version see page no. 2/51

AX260 ... AX370 3-pole contactors

132 to 200 kW

AC operated



AX260 ... AX370

Description

AX260 ... AX370 contactors are mainly used for controlling 3-phase motors and power circuits up to 690 V AC.

These contactors are of the block type design with:

- 3 main poles and side mounted auxiliary contact block
- control circuit: AC operated
- add-on auxiliary contact blocks for side mounting and a wide range of accessories.

Ordering details

IEC	Rated operational power		Rated control circuit voltage U _c (1)		Auxiliary contacts fitted	Type	Order code	Weight	
	400 V	θ ≤ 40 °C	V 50 Hz	V 60 Hz					Pkg (1 pce)
AC-3	AC-1	kW	A					kg	
132	400			24	24	1 1	AX260-30-11-81	1SFL547074R8111	5.4
				110	110...120	1 1	AX260-30-11-84	1SFL547074R8411	5.4
				220...230	230...240	1 1	AX260-30-11-80	1SFL547074R8011	5.4
				230...240	240...260	1 1	AX260-30-11-88	1SFL547074R8811	5.4
				400...415	415...440	1 1	AX260-30-11-86	1SFL547074R8611	5.4
160	500			24	24	1 1	AX300-30-11-81	1SFL587074R8111	5.4
				110	110...120	1 1	AX300-30-11-84	1SFL587074R8411	5.4
				220...230	230...240	1 1	AX300-30-11-80	1SFL587074R8011	5.4
				230...240	240...260	1 1	AX300-30-11-88	1SFL587074R8811	5.4
				400...415	415...440	1 1	AX300-30-11-86	1SFL587074R8611	5.4
200	600			24	24	1 1	AX370-30-11-81	1SFL607074R8111	5.4
				110	110...120	1 1	AX370-30-11-84	1SFL607074R8411	5.4
				220...230	230...240	1 1	AX370-30-11-80	1SFL607074R8011	5.4
				230...240	240...260	1 1	AX370-30-11-88	1SFL607074R8811	5.4
				400...415	415...440	1 1	AX370-30-11-86	1SFL607074R8611	5.4

(1) for other voltage version see page no. 2/51

AX09 ... AX150 3-pole contactors

Main accessories

Contactor and main accessories (other accessories available)

2

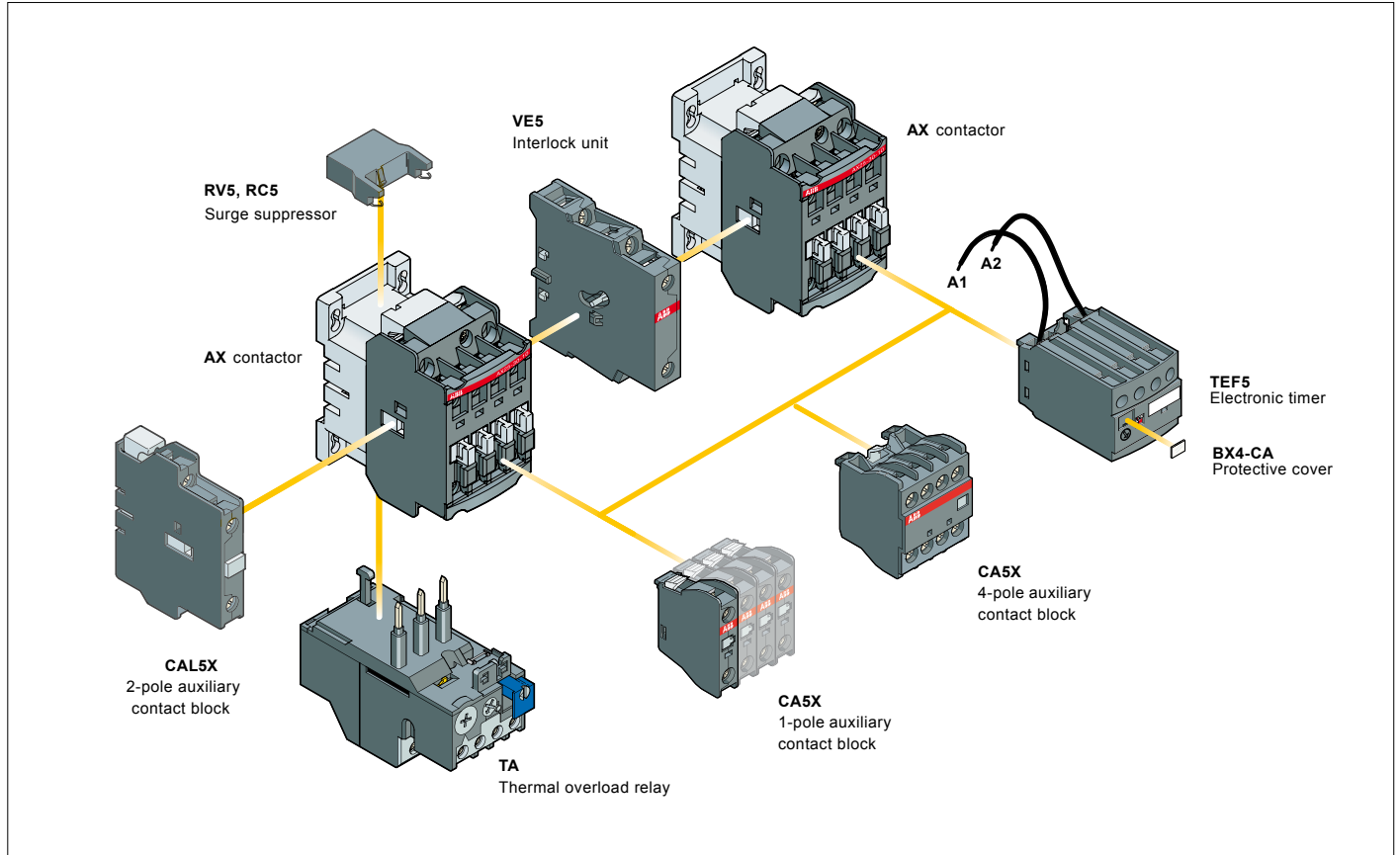

Main accessory fitting details

Many configurations of accessories are possible depending on whether these are front-mounted or side-mounted.

Contactor types	Main poles	Built-in auxiliary contacts	Front-mounted accessories			Side-mounted accessories	
			Auxiliary contact blocks		Electronic timer	Auxiliary contact blocks	Interlock unit blocks
			1-pole CA5X	4-pole CA5X	TEF5	2-pole CALX	VM5 or VE5
AX09 ... AX25	3 0 3 0	1 0 0 1 (1)	1 to 4 x CA5X	or 1 x CA5X (4-pole)	or 1 x TEF5	+ 1 to 2 x CALX5-11	or 1 x VM5-1 or VE5-1 + 1 x CALX5-11
AX32, AX40	3 0 3 0	1 0 0 1 (1)	1 to 5 x CA5X	or 1 x CA5X (4-pole) + 1 x 1-pole CA5X	or 1 x TEF5 + 1 x CA5X (1-pole)	+ 1 to 2 x CALX5-11	or 1 x VM5-1 or VE5-1 + 1 x CALX5-11
AX50 ... AX80	3 0	1 1	1 to 6 x CA5X	or 1 x CA5X (4-pole) + 2 x 1-pole CA5X	or 1 x TEF5 + 2 x CA5X (1-pole)	+ 1 x CALX5-11	or 1 x VE5-2
AX95 ... AX150	3 0	1 1	1 to 6 x CA5X	or 1 x CA5X (4-pole) + 2 x 1-pole CA5X	-	+ 1 x CALX18-11	or 1 x VE5-2

(1) 2 N.C. CA5X auxiliary contacts maximum in mounting position 5. for mounting position refer technical data page.

Overload relays fitting details (1)

Contactor types	Thermal overload relays	Electronic overload relays
AX09 ... AX18	TA25DU-M (0.1...0.32 A)	E16DU (0.10 ... 18.9 A)
AX25	TA25DU-M (0.1...0.32 A)	
AX32, AX40	TA25DU-M (0.1...0.32 A) or TA42DU-M (18...42 A)	E45DU (9 ... 45 A)
AX50 ... AX80	TA75DU-M (18...80 A)	E80DU (27 ... 80 A)
AX95 ... AX150	TA80DU (29...80 A) or TA110DU (66...110 A)	E140DU (50 ... 140 A)

The addition of a thermal overload relay on the contactor does not prevent fitting of many other accessories as shown above.

(1) Direct mounting - No kit required.

AX185 ... AX370 3-pole contactors

Main accessories

Main accessories (other accessories available)

AX185, AX205

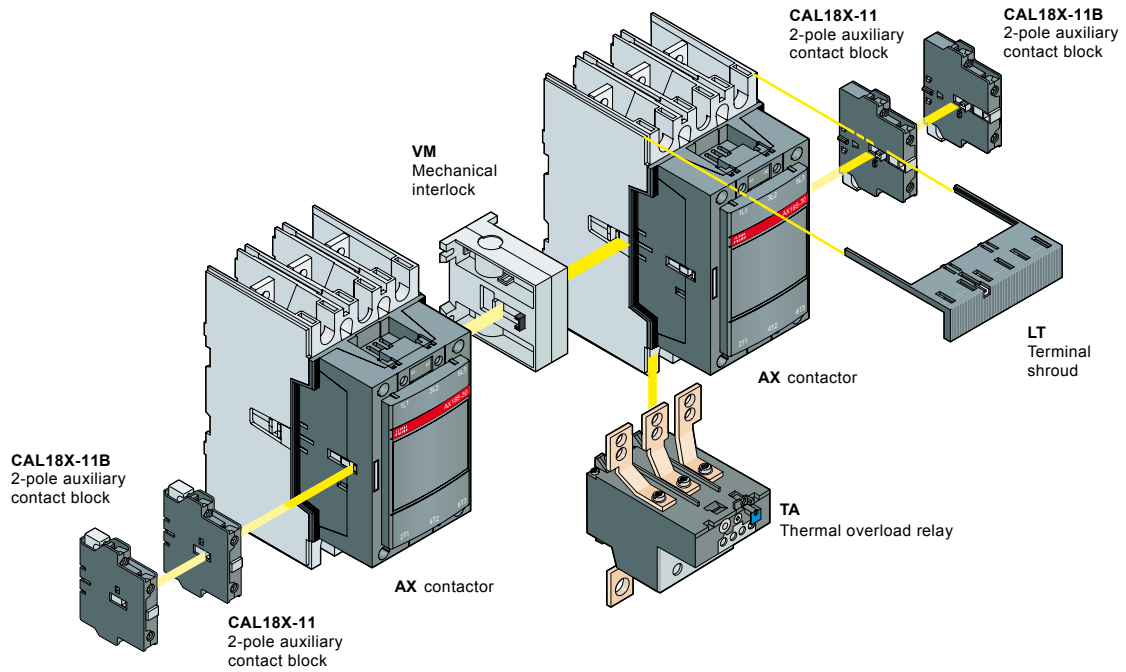

AX260 ... AX370

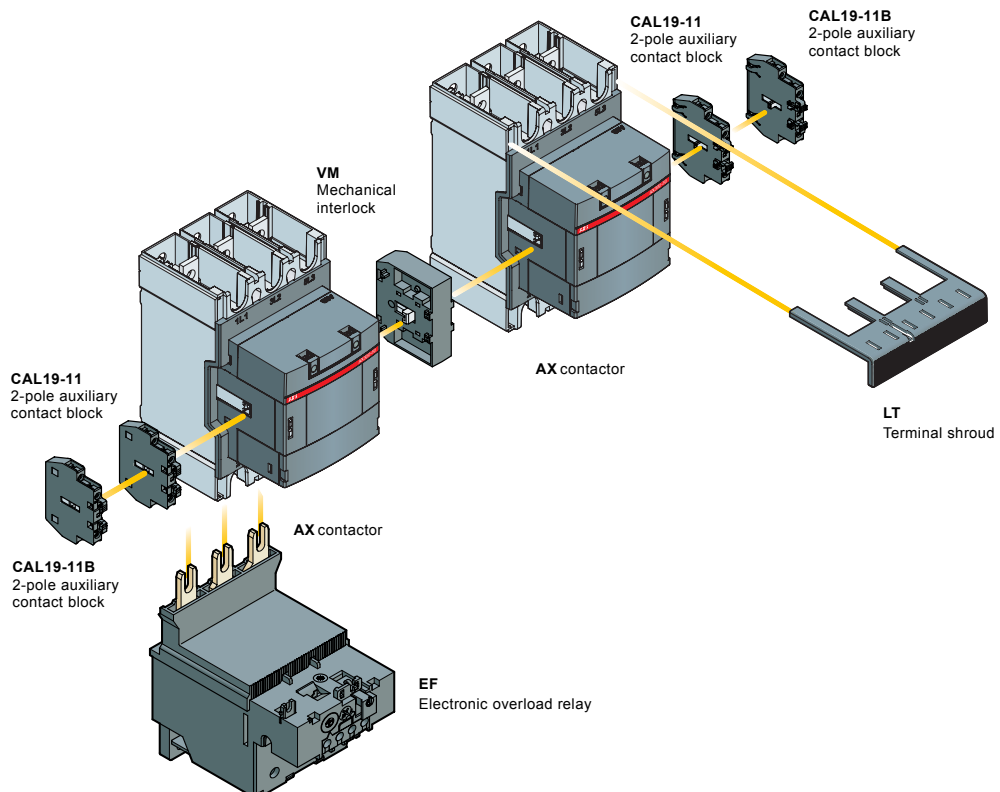

AX185 ... AX370 3-pole contactors

Main accessories

2

Main accessory fitting details

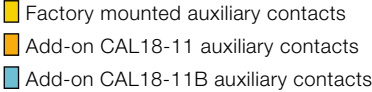
Contactor types	Main poles	Available auxiliary contacts	Side-mounted accessories Add-on auxiliary contact blocks CAL18X-11, CAL18X-11B, CAL19-11, CAL19-11B	Mechanical interlock units	Mounting and positioning 
-----------------	------------	------------------------------	---	----------------------------	---

Contactor types + auxiliary contact blocks

AX185 ... AX205	3	0	1	1	1 x CAL18X-11	+	2 x CAL18X-11B	-	
AX260 ... AX370	3	0	1	1	1 x CAL19-11	+	2 x CAL19-11B	-	

(1) Total number of auxiliary contact blocks for the two contactors.

Contactor types with mechanical interlocking + auxiliary contact blocks

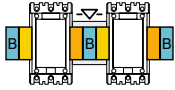
AX185 ... AX205	3	0	1	1	2 x CAL18-11 (1)	+	2 x CAL18-11B (1)	+	VM...H (2)	
AX260 ... AX370	3	0	1	1	-	+	2 x CAL19-11B	+	VM... (2)	

(1) Total number of auxiliary contact blocks for the two contactors

(2) Interlock type, according to the contactor ratings (see "Accessories")

Overload relays fitting details (1)

Contactor types	Thermal overload relays	Electronic overload relays
AX185, AX205	TA200DU (66 ... 200 A)	EF205 (63 ... 210 A)
AX260 ... AX370	-	EF370 (115 ... 380 A)

The addition of a thermal overload relay on the contactor does not prevent fitting of many other accessories as shown above.

(1) Direct mounting - No kit required.

AX09 ... AX150 3-pole contactors

Main accessories

Ordering details (1)

For contactors	Auxiliary contacts	Type	Order code	Pkg qty	Weight (1 pce)
					kg

Front-mounted instantaneous auxiliary contact blocks

AX09 ... AX150 and NX 4-pole	1 -	CA5X-10	1SBN019010R1010	10	0.014
AX50...AX150	- 1	CA5X-01	1SBN019010R1001	10	0.014
	2 2	CA5X-22E	1SBN019040R1022	2	0.060
	3 1	CA5X-31E	1SBN019040R1031	2	0.060
	4 0	CA5X-40E	1SBN019040R1040	2	0.060
	0 4	CA5X-04E	1SBN019040R1004	2	0.060
AX09...AX40-30-10	2 2	CA5X-22M	1SBN019040R1122	2	0.060
	3 1	CA5X-31M	1SBN019040R1131	2	0.060
	4 0	CA5X-40M	1SBN019040R1140	2	0.060
	0 4	CA5X-04M	1SBN019040R1104	2	0.060
AX09...AX40-30-01	2 2	CA5X-22U	1SBN019040R1322	2	0.060
	3 1	CA5X-31U	1SBN019040R1331	2	0.060
	4 0	CA5X-40U	1SBN019040R1340	2	0.060
	0 4	CA5X-04U	1SBN019040R1304	2	0.060
NX 4-pole	2 2	CA5X-22N	1SBN019040R1222	2	0.060
	3 1	CA5X-31N	1SBN019040R1231	2	0.060
	0 4	CA5X-04N	1SBN019040R1204	2	0.060
	4 0	CA5X-40N	1SBN019040R1240	2	0.060

Side-mounted instantaneous auxiliary contact block, 2 pole

AX09 ... AX80 and NX - 4 pole	1 1	CAL5X-11	1SBN019020R1011	2	0.050
AX95 ... AX205 (1)	1 1	CAL18X-11	1SBN019820R1011	2	0.050

Mechanical interlock units for two horizontal mounted contactors(2)

Left side contactor	Right side contactor	Mounting					
AX09 ... AX40	AX09 ... AX40	Mech.	- -	VM5-1	1SBN030100R1000	1	0.066
AX95 ... AX205	AX185 ... AX205	Mech.	- -	VM300H	1SBN034700R1000	1	0.150

Mechanical and electrical interlock units for two horizontal mounted contactors

Left side contactor	Right side contactor	Mounting					
AX09...AX40	AX09...AX40	Mech. + Elect.	- 2	VE5-1	1SBN030110R1000	1	0.076
AX32...AX80	AX50...AX80	Mech. + Elect.	- 2	VE5-2	1SBN030210R1000	1	0.146
AX50...AX80	AX32...AX80	Mech. + Elect.	- 2	VE5-2	1SBN030210R1000	1	0.146
AX50...AX80	AX95...AX150	Mech. + Elect.	- 2	VE5-2(3)	1SBN030210R1000	1	0.146
AX95...AX150	AX50...AX80	Mech. + Elect.	- 2	VE5-2(3)	1SBN030210R1000	1	0.146
AX95...AX150	AX95...AX150	Mech. + Elect.	- 2	VE5-2	1SBN030210R1000	1	0.146

(1) See "Main accessory fitting details".

(2) Mechanical durability: VM5-1 = 5 millions cycles, VM300H = 1 million cycles.

(3) The combination of AX50 ... AX80 contactors interlocked with AX95...AX150 contactors cannot be mounted on symmetrical rail (75 mm, IEC/EN 60715).



CA5X-10

AX07015



CA5X-4P

AX07013 CA5X 4P



CAL5X-11

1SBC5752F0301



VE5-1

AX07021

AX09 ... AX150 3-pole contactors

Main accessories

2



1SBC101396F0014

TEF5-OFF



1SBC692819F0301

BEA



1SBC574001F0301

RV5/50



1SBC66489F0301

WB75-A

Ordering details (1)

For contactors	Time delay range selected by switch	Delay type	Auxiliary contacts	Type	Order code	Pkg qty	Weight (1 pce) kg
			1 1				

Electronic timers

AX09 ... AX80	0.1...1 s	ON-delay	1 1	TEF5-ON	1SBN020312R1000	1	0.065
NX 4 pole	1...10 s	OFF-delay	1 1	TEF5-OFF	1SBN020314R1000	1	0.065
	10...100 s						

Note: Rated control circuit voltage U_c 24...240 V 50/60 Hz or DC.

Connecting links with manual motor starters

For contactors	MMS type	Type	Order code	Pkg qty	Weight (1 pce) kg
AX09...AX18	MS116-0.16 ... MS116-16 / MS132-0.16 ... MS132-10	BEA16/116	1SBN081406R1000	10	0.020
AX25	MS116-0.16 ... MS116-16 / MS132-0.16 ... MS132-10	BEA25/116	1SBN089306T1000	10	0.020
AX25	MS116-20 ... MS116-32 / MS132-12 ... MS132-32	BEA25/132	1SBN089306T1001	10	0.020
AX32 ... AX40	MS450	BEA40/450	1SBN083206R1000	1	0.061
AX50	MS450	BEA50/450	1SBN083506R1000	1	0.062
AX50 ... AX80	MS495	BEA75/495	1SBN084106R1000	1	0.120
AX95 ... AX150	MS495	BEA100/495	1SBN084506R1000	1	0.124

For contactors	Rated control circuit voltage U_c V AC	Type	Order code	Pkg qty	Weight (1 pce) kg
----------------	--	------	------------	---------	-------------------

Surge suppressors

AX09 ... AX150	24...50	RV5/50	1SBN050010R1000	2	0.015
	50...133	RV5/133	1SBN050010R1001	2	0.015
	110...250	RV5/250	1SBN050010R1002	2	0.015
	250...440	RV5/440	1SBN050010R1003	2	0.015
AX09 ... AX40	24...50	RC5-1/50	1SBN050100R1000	2	0.012
	50...133	RC5-1/133	1SBN050100R1001	2	0.012
	110...250	RC5-1/250	1SBN050100R1002	2	0.012
	250...440	RC5-1/440	1SBN050100R1003	2	0.012
AX50 ... AX150	24...50	RC5-2/50	1SBN050200R1000	2	0.015
	50...133	RC5-2/133	1SBN050200R1001	2	0.015
	110...250	RC5-2/250	1SBN050200R1002	2	0.015
	250...440	RC5-2/440	1SBN050200R1003	2	0.015

Mechanical latching units

For contactors	Rated control circuit voltage U_c		Type	Order code	Pkg qty	Weight (1 pce) kg
	50Hz	60 Hz				
AX09...AX80	24	24...28	WB75-A	FPTN372726R1001	1	0.120
	220...230	220...255	WB75-A	FPTN372726R1006	1	0.120

(1) See "Main accessory fitting details".

AX185 ... AX370 3-pole contactors

Main accessories



1SFC101033FC201

CAL18X-11



1SBC560411F0301

VM300H



1SFT98099-019C3

LT...AC



1SFT9099-125

LT...AL



1SFT98000-011C3

LW



1SFT98000-012C3

LX



1SBC574001F0301

RV5/50

Ordering details (1)

For contactors	Auxiliary contacts	Type	Order code	Pkg qty	Weight (1 pce)
	1 1				kg

Side-mounted instantaneous auxiliary contact blocks

AX185 ... AX205	1 1	CAL18X-11	1SFN019820R1011	2	0.050
	1 1	CAL18X-11B	1SFN019820R3311	2	0.050
AX260 ... AX370	1 1	CAL19-11	1SFN010820R1011	2	0.040
	1 1	CAL19-11B	1SFN010820R3311	2	0.040

Mechanical interlock unit for two horizontal mounted contactors

Left side contactor	Right side contactor	Mounting				
AX95 ... AX205	AX185 ... AX205	Mech.	-	VM300H	1SFN034700R1000	1 0.150
AX260 ... AX370	AX260 ... AX370	Mech.	-	VM19	1SFN030300R1000	1 0.054

Terminal shrouds

AX185 ... AX205 with connectors	LT185-AC	1SFN124701R1000	2	0.050
AX185 ... AX205 with lugs	LT185-AL	1SFN124703R1000	2	0.220
AX260 ... AX370 with connectors	LT370-30C	1SFN125401R1000	2	0.035
AX260 ... AX370 with lugs	LT370-30L	1SFN125403R1000	2	0.280

For contactors	Dimensions		Type	Order code	Pkg qty	Weight (1 pce)
	hole Ø	bar				
	mm	mm				kg

Terminal extension

AX185	10.5	20 x 5	LX185	1SFN074707R1000	1	0.250
AX205 ... AX300	10.5	25 x 5	LX300	1SFN075107R1000	1	0.450

Terminal enlargements

AX185	8.5	20 x 5	LW185	1SFN074710R1000	1	0.250
AX205 ... AX300	10.5	20 x 5	LW300	1SFN075110R1000	1	0.350

Surge suppressor

For contactors	Rated control circuit voltage U _c	Type	Order code	Pkg qty	Weight (1 pce)
	V AC				kg
AX185 ... AX205	250...440	RC5-3/440	1SFN050300R1003	2	0.028

(1) See "Main accessory fitting details".

AX09 ... AX40 3-pole contactors

Technical data

Main pole - Utilization characteristics according to IEC

Contactor types	AC operated	AX09	AX12	AX18	AX25	AX32	AX40
Standards		IEC 60947-1 / 60947-4-1 and EN 60947-1 / 60947-4-1					
Rated operational voltage Ue max.		690 V					
Rated frequency limits		25 ... 400 Hz					
Rated frequency (without derating)		50 / 60 Hz					
Conventional free-air thermal current Ith							
acc. to IEC 60947-4-1, open contactors, $\theta \leq 40^\circ\text{C}$		24 A	26 A	28 A	32 A	65 A	65 A
With conductor cross-sectional area		4 mm ²	4 mm ²	4 mm ²	6 mm ²	16 mm ²	16 mm ²
AC-1 Utilization category							
For air temperature close to contactor							
Ie / Rated operational current AC-1	$\theta \leq 40^\circ\text{C}$	22 A	25 A	27 A	32 A	55 A	60 A
Ue max. $\leq 690\text{ V}$, 50/60 Hz	$\theta \leq 55^\circ\text{C}$	22 A	22 A	25 A	27 A	55 A	60 A
	$\theta \leq 70^\circ\text{C}$	18 A	18 A	20 A	23 A	39 A	42 A
With conductor cross-sectional area		2.5 mm ²	2.5 mm ²	4 mm ²	6 mm ²	10 mm ²	16 mm ²
AC-3 Utilization category							
For air temperature close to contactor $\theta \leq 55^\circ\text{C}$							
Ie / Max. rated operational current AC-3 (1)							
	220-230-240 V	9 A	12 A	18 A	25 A	32 A	40 A
	380-400 V	9 A	12 A	18 A	25 A	32 A	40 A
	415 V	9 A	12 A	18 A	25 A	32 A	40 A
	440 V	9 A	9 A	12 A	16 A	32 A	37 A
	500 V	9 A	9 A	12 A	14 A	28 A	33 A
	690 V	7 A	7 A	9 A	10 A	21 A	25 A
Rated operational power	AC-3 (1)						
	220-230-240 V	2.2 kW	3 kW	4 kW	6.5 kW	9 kW	11 kW
	380-400 V	4 kW	5.5 kW	7.5 kW	11 kW	15 kW	18.5 kW
	415 V	4 kW	5.5 kW	9 kW	11 kW	15 kW	18.5 kW
	440 V	4 kW	4 kW	5.5 kW	9 kW	18.5 kW	22 kW
	500 V	5.5 kW	5.5 kW	7.5 kW	9 kW	18.5 kW	22 kW
	690 V	5.5 kW	5.5 kW	7.5 kW	9 kW	18.5 kW	22 kW
Rated making capacity AC-3		10 x Ie AC-3 acc. to IEC 60947-4-1					
Rated breaking capacity AC-3		8 x Ie AC-3 acc. to IEC 60947-4-1					
AC-8a Utilization category							
(without thermal overload relay - Ue 400 V 50/60 Hz - $\theta \leq 40^\circ\text{C}$)							
Ie / Rated operational current AC-8a		12 A	16 A	22 A	30 A	40 A	50 A
Rated operational power AC-8a		5.5 kW	5.5 kW	7.5 kW	11 kW	20 kW	22 kW
Short-circuit protection device for contactors							
without thermal overload relay - Motor protection excluded (2)							
Ue $\leq 500\text{ V AC}$ - gG type fuse		25 A	25 A	32 A	32 A	63 A	63 A
Rated short-time withstand current Icw	1 s	250 A	250 A	280 A	300 A	600 A	600 A
at 40 °C ambient temperature,	10 s	100 A	100 A	120 A	140 A	400 A	400 A
in free air from a cold state	30 s	60 A	60 A	70 A	80 A	225 A	225 A
	1 min	50 A	50 A	55 A	60 A	150 A	150 A
	15 min	26 A	26 A	28 A	30 A	65 A	65 A
Maximum breaking capacity							
cos $\phi = 0.45$							
	at 440 V	250 A	250 A	250 A	250 A	820 A	820 A
	at 690 V	90 A	90 A	90 A	90 A	340 A	340 A
Power dissipation per pole							
	Ie / AC-1	0.8 W	0.8 W	1 W	1.2 W	2.5 W	3 W
	Ie / AC-3	0.1 W	0.1 W	0.2 W	0.35 W	0.9 W	1.3 W
Electrical durability (1x10⁶)	400/415V, AC-3	1.5	1.5	1.5	1.3	1.5	1.5
Max. electrical switching frequency	AC-1	600 cycle/h					
	AC-3	1200 cycle/h					
Mechanical durability							
Number of operating cycles		10 millions operating cycles					
Max. switching frequency		3600 cycles/h					



3-phase motors



1500 r.p.m. 50 Hz
1800 r.p.m. 60 Hz
3-phase motors



(1) For the corresponding kW/A values of 1500 r.p.m, 50 Hz or 1800 r.p.m, 60 Hz, 3-phase motors, see "Motor rated operational powers and currents".

(2) For the protection of motor starters against short circuits, see "Coordination with short-circuit protection devices".

AX50 ... AX150 3-pole contactors

Technical data

Main pole - Utilization characteristics according to IEC

Contactor types	AC operated	AX50	AX65	AX80	AX95	AX115	AX150
Standards		IEC 60947-1 / 60947-4-1					
Rated operational voltage Ue max.		690 V			1000 V		
Rated frequency limits		25 ... 400 Hz					
Rated frequency (without derating)		50 / 60 Hz					
Conventional free-air thermal current Ith		acc. to IEC 60947-4-1, open contactors, $\theta \leq 40^\circ\text{C}$					
	With conductor cross-sectional area	100 A	125 A	125 A	145 A	160 A	190 A
		35 mm ²	50 mm ²	50 mm ²	50 mm ²	70 mm ²	95 mm ²
AC-1 Utilization category		For air temperature close to contactor					
Ie / Rated operational current AC-1	$\theta \leq 40^\circ\text{C}$	100 A	115 A	125 A	145 A	160 A	190 A
	Ue max. $\leq 690\text{ V}$, 50/60 Hz						
	$\theta \leq 55^\circ\text{C}$	85 A	95 A	105 A	135 A	145 A	145 A
	$\theta \leq 70^\circ\text{C}$	70 A	80 A	85 A	115 A	130 A	130 A
	With conductor cross-sectional area	35 mm ²	50 mm ²	50 mm ²	50 mm ²	70 mm ²	95 mm ²
AC-3 Utilization category		For air temperature close to contactor $\theta \leq 55^\circ\text{C}$					
Ie / Max. rated operational current AC-3 (1)							
	220-230-240 V	53 A	65 A	80 A	96 A	115 A	150 A
	380-400 V	50 A	65 A	80 A	96 A	115 A	150 A
	415 V	50 A	65 A	80 A	96 A	115 A	150 A
	440 V	45 A	65 A	70 A	93 A	100 A	100 A
	500 V	45 A	55 A	65 A	80 A	100 A	100 A
	690 V	35 A	43 A	46 A	65 A	82 A	82 A
 3-phase motors							
Rated operational power	AC-3 (1)						
	220-230-240 V	15 kW	18.5 kW	22 kW	25 kW	30 kW	45 kW
	380-400 V	22 kW	30 kW	37 kW	45 kW	55 kW	75 kW
	415 V	25 kW	37 kW	40 kW	55 kW	59 kW	75 kW
	440 V	25 kW	37 kW	40 kW	55 kW	59 kW	59 kW
	500 V	30 kW	37 kW	45 kW	55 kW	59 kW	59 kW
	690 V	30 kW	37 kW	40 kW	55 kW	75 kW	75 kW
 1500 r.p.m. 50 Hz 1800 r.p.m. 60 Hz 3-phase motors							
Rated making capacity AC-3		10 x Ie AC-3 acc. to IEC 60947-4-1					
Rated breaking capacity AC-3		8 x Ie AC-3 acc. to IEC 60947-4-1					
AC-8a Utilization category		(without thermal overload relay - Ue 400 V 50/60 Hz - $\theta \leq 40^\circ\text{C}$)					
Ie / Rated operational current AC-8a		63 A	85 A	95 A	120 A	140 A	-
Rated operational power AC-8a		30 kW	45 kW	45 kW	55 kW	55 kW	-
Short-circuit protection device for contactors		without thermal overload relay - Motor protection excluded (2)					
	Ue $\leq 500\text{ V AC}$ - gG type fuse	100 A	125 A	160 A	160 A	200 A	315 A
Rated short-time withstand current Icw	1 s	1000 A	1000 A	1000 A	1320 A	1320 A	1320 A
	10 s	650 A	650 A	650 A	800 A	800 A	800 A
	30 s	370 A	370 A	370 A	500 A	500 A	500 A
	1 min	250 A	250 A	250 A	350 A	350 A	350 A
	15 min	110 A	135 A	135 A	160 A	160 A	160 A
Maximum breaking capacity		cos $\phi = 0.45$					
	at 440 V	1300 A	1300 A	1300 A	1160 A	1160 A	1160 A
	at 690 V	630 A	630 A	630 A	800 A	800 A	800 A
Power dissipation per pole	Ie / AC-1	5 W	6.5 W	7 W	6.5 W	6.5 W	6.5 W
	Ie / AC-3	1.3 W	1.5 W	2 W	2.7 W	2.7 W	2.7 W
Electrical durability (1x10⁶)	400/415V, AC-3	1.2	1.2	1.1	0.8	0.6	0.6
Max. electrical switching frequency	AC-1	600 cycle/h			300 cycles/h		
	AC-3	600 cycle/h			300 cycles/h		
Mechanical durability		10 millions operating cycles					
	Number of operating cycles	10 millions operating cycles					
	Max. switching frequency	3600 cycles/h					

AX185 ... AX370 3-pole contactors

Technical data

Main pole - Utilization characteristics according to IEC

Contactor types	AC operated	AX185	AX205	AX260	AX300	AX370
Standards		IEC 60947-1 / 60947-4-1 / EN 60947-1 / 60947-4-1				
Rated operational voltage U_e max.		1000 V				
Rated frequency limits		25 ... 400 Hz				
Rated frequency (without derating)		50 / 60 Hz				
Conventional free-air thermal current I_{th}						
acc. to IEC 60947-4-1, open contactors, $\theta \leq 40^\circ\text{C}$		250 A	275 A	400 A	500 A	600 A
With conductor cross-sectional area		120 mm ²	150 mm ²	240 mm ² (1)	300 mm ²	2X185 mm ² (2)
AC-1 Utilization category						
For air temperature close to contactor						
I_e / Rated operational current AC-1	$\theta \leq 40^\circ\text{C}$	250 A	275 A	400 A	500 A	600 A
U _e max. $\leq 690\text{ V}$, 50/60 Hz	$\theta \leq 55^\circ\text{C}$	230 A	250 A	350 A	400 A	500 A
	$\theta \leq 70^\circ\text{C}$	180 A	180 A	290 A	325 A	400 A
With conductor cross-sectional area		120 mm ²	150 mm ²	240 mm ² (1)	300 mm ²	2X185 mm ² (2)
AC-3 Utilization category						
For air temperature close to contactor $\theta \leq 55^\circ\text{C}$						
I_e / Max. rated operational current AC-3 (1)						
	220-230-240 V	185 A	205 A	265 A	305 A	370 A
	380-400 V	185 A	205 A	265 A	305 A	370 A
	415 V	185 A	205 A	265 A	305 A	370 A
	440 V	145 A	185 A	265 A	305 A	370 A
	500 V	145 A	170 A	250 A	290 A	315 A
	690 V	120 A	170 A	250 A	290 A	315 A
Rated operational power	AC-3 (1)					
	220-230-240 V	55 kW	59 kW	75 kW	90 kW	110 kW
	380-400 V	90 kW	110 kW	132 kW	160 kW	200 kW
	415 V	90 kW	110 kW	132 kW	160 kW	200 kW
	440 V	75 kW	90 kW	160 kW	160 kW	200 kW
	500 V	90 kW	110 kW	160 kW	200 kW	250 kW
	690 V	110 kW	132 kW	200 kW	250 kW	315 kW
Rated making capacity AC-3		10 x I _e AC-3 acc. to IEC 60947-4-1				
Rated breaking capacity AC-3		8 x I _e AC-3 acc. to IEC 60947-4-1				
AC-8a Utilization category						
(without thermal overload relay - U _e 400 V 50/60 Hz - $\theta \leq 40^\circ\text{C}$)						
I _e / Rated operational current AC-8a		-	-	-	-	-
Rated operational power AC-8a		-	-	-	-	-
Short-circuit protection device for contactors						
without thermal overload relay - Motor protection excluded (2)						
U _e $\leq 500\text{ V AC}$ - gG type fuse		355 A	355 A	500 A	500 A	630 A
Rated short-time withstand current I_{cw}						
at 40 °C ambient temperature,	1 s	1800 A	1800 A	2650 A	3050 A	3700 A
in free air from a cold state	10 s	1200 A	1200 A	2120 A	2440 A	2960 A
	30 s	800 A	800 A	1224 A	1409 A	1709 A
	1 min	600 A	600 A	865 A	996 A	1208 A
	15 min	280 A	280 A	400 A	500 A	600 A
Maximum breaking capacity						
cos $\phi = 0.45$	at 440 V	1500 A	1500 A	3800 A	4600 A	5000 A
	at 690 V	1200 A	1200 A	3300 A	3800 A	4000 A
Power dissipation per pole	I_e / AC-1	13 W	13 W	32 W	50 W	72 W
	I_e / AC-3	5 W	5 W	14 W	19 W	27 W
Electrical durability (1x10⁶)	400/415V, AC-3	0.8	0.7	0.5	0.5	0.5
Max. electrical switching frequency	AC-1	300 cycles/h				
	AC-3	300 cycles/h				
Mechanical durability						
Number of operating cycles		5 millions operating cycles				
Max. switching frequency		3600 cycles/h		300 cycles/h		

(1) For currents above 275 A use terminal enlargements or terminal extensions

(2) For currents above 450 A use terminal enlargements or terminal extensions

AX09 ... AX40 3-pole contactors

Technical data

General technical data

Contactor types	AC operated	AX09	AX12	AX18	AX25	AX32	AX40
Rated insulation voltage Ui acc. to IS / IEC 60947-4-1		690 V					
Rated impulse withstand voltage Uimp.		6 kV					
Ambient air temperature close to contactor							
Operation	Fitted with thermal overload relay	-25...+55 °C (1)					
	Without thermal overload relay	-40...+70 °C					
Storage		-60...+80 °C					
Climatic withstand		acc. to IEC 60068-2-30 and 60068-2-11 - UTE C 63-100 specification II					
Maximum operating altitude (without derating)		3000 m					
Shock withstand acc. to IEC 60068-2-27 and EN 60068-2-27 Mounting position 1							
	Shock direction	1/2 sinusoidal shock for 11 ms: no change in contact position, closed or open position(2)					
	A	20 g					
	B1	10 g closed position / 5 g open position					
	B2	15 g					
	C1	20 g					
	C2	20 g					

(1) The max. operational current is 23A for AX25 with TA25DU-25M; the max. operational current is 74A for AX80 with TA75DU-80M; the max. operational current is 182A for AX205 with TA200DU-200

(2) These values are not valid for rail mounting with contactors AX95 ... AX150.

Magnet system characteristics

Contactor types	AC operated	AX09	AX12	AX18	AX25	AX32	AX40
Coil operating limits acc. to IS / IEC 60947-4-1	AC supply	at $\theta \leq 55\text{ °C}$ 0.85...1.1 x Uc					
		Please also refer to "Mounting characteristics and conditions for use"					
AC control voltage 50/60 Hz							
Rated control circuit voltage Uc	at 50 Hz	24...440 V					
	at 60 Hz	24...440 V					
Coil consumption	Average pull-in value	50 Hz	70 VA			120 VA	
		60 Hz	80 VA			140 VA	
	Average holding value	50/60 Hz (1)	74 VA / 70 VA			125 VA / 120 VA	
		50 Hz	8 VA / 2 W			12 VA / 3 W	
		60 Hz	8 VA / 2 W			12 VA / 3 W	
		50/60 Hz (1)	8 VA / 2 W			12 VA / 3 W	
Drop-out voltage		approx. 40...65 % of Uc					
Operating time							
Between coil energization and:	N.O. contact closing	10...26 ms				8...21 ms	
	N.C. contact opening	7...21 ms				6...18 ms	
Between coil de-energization and:	N.O. contact opening	4...11 ms				4...11 ms	
	N.C. contact closing	9...16 ms				7...14 ms	

(1) 50/60 Hz coils: see "Coil voltage code table".

Mounting characteristics and conditions for use

Contactor types	AC operated	AX09	AX12	AX18	AX25	AX32	AX40
Mounting positions							
		Max. N.O. or N.C. built-in and add-on N.O. or N.C. auxiliary contacts: see accessory fitting details for 3-pole contactor AX9 ... AX150					
Control voltage / Ambient temperature							
Mounting positions	1, 1±30°, 2, 3, 4, 5	at $\theta \leq 55\text{ °C}$		0.85...1.1 x Uc			
		at $55\text{ °C} \leq \theta \leq 70\text{ °C}$		Uc			
	6	at $\theta \leq 55\text{ °C}$		0.95...1.1 x Uc			
		at $\theta \leq 55\text{ °C}$		Unauthorized			
Mounting distances		The contactors can be assembled side by side					
Fixing							
On rail according to IEC 60715, EN 60715		35 x 7.5 mm or 35 x 15 mm					
By screws (not supplied)		2 x M4 screws placed diagonally					

AX50 ... AX150 3-pole contactors

Technical data

General technical data

Contactor types	AC operated	AX50	AX65	AX80	AX95	AX115	AX150
Rated insulation voltage U_i acc. to IEC 60947-4-1		690 V			1000 V		
Rated impulse withstand voltage U_{imp}		6 kV			8 kV		
Ambient air temperature close to contactor							
Operation	Fitted with thermal overload relay	-25...+55 °C(1)					
Storage	Without thermal overload relay	-40...+70 °C					
Climatic withstand		acc. to IEC 60068-2-30 and 60068-2-11		acc. to IEC 60068-2-30			
Maximum operating altitude (without derating)		UTE C 63-100 specification II					
Shock withstand acc. to IEC 60068-2-27 and EN 60068-2-27		3000 m					
Mounting position 1							
	Shock direction	1/2 sinusoidal shock for 11 ms: no change in contact position, closed or open position(2)					
	A	20 g					
	B1	10 g closed position / 5 g open position					
	B2	15 g					
	C1	20 g					
	C2	20 g					

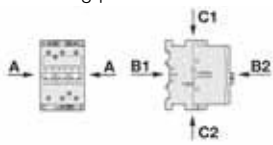

(1) The max. operational current is 23A for AX25 with TA25DU-25M; the max. operational current is 74A for AX80 with TA75DU-80M; the max. operational current is 182A for AX205 with TA200DU-200

(2) These values are not valid for rail mounting with contactors AX95 ... AX150.

Magnet system characteristics

Contactor types	AC operated	AX50	AX65	AX80	AX95	AX115	AX150
Coil operating limits acc. to IEC 60947-4-1	AC supply	at $\theta \leq 55$ °C 0.85...1.1 x U_c			At $\theta \leq 70$ °C 0.85 ... 1.1 x U_c		
		Please also refer to "Mounting characteristics and conditions for use"					
AC control voltage 50/60 Hz							
Rated control circuit voltage U_c	at 50 Hz	24...440 V					
	at 60 Hz	24...440 V					
Coil consumption	Average pull-in value	50 Hz		180 VA		350 VA	
		60 Hz		210 VA		450 VA	
		50/60 Hz (1)		190 VA / 180 VA		410 VA / 365 VA	
	Average holding value	50 Hz		18 VA / 5.5 W		22 VA / 6.5 W	
		60 Hz		18 VA / 5.5 W		26 VA / 8 W	
		50/60 Hz (1)		18 VA / 5.5 W		27 VA / 7.5 W	
Drop-out voltage		approx. 40...65 % of U_c					
Operating time							
Between coil energization and:	N.O. contact closing	8...27 ms				10...25 ms	
	N.C. contact opening	7...22 ms				7...22 ms	
Between coil de-energization and:	N.O. contact opening	4...11 ms				7...15 ms	
	N.C. contact closing	7...14 ms				10...18 ms	

(1) 50/60 Hz coils: see "Coil voltage code table".

Mounting characteristics and conditions for use

Contactor types	AC operated	AX50	AX65	AX80	AX95	AX115	AX150
Mounting positions							
		Add on max. N.O. or N.C. auxiliary contacts: see accessory fitting details for 3-pole contactor AX9 ... AX150					
Control voltage / Ambient temperature							
Mounting positions	1, 1±30°, 2, 3, 4, 5	at $\theta \leq 55$ °C		0.85...1.1 x U_c			
		at 55 °C $\leq \theta \leq 70$ °C		0.85...1.1 x U_c			
	6	at $\theta \leq 55$ °C		0.95...1.1 x U_c			
		at $\theta \leq 55$ °C		Unauthorized			
Mounting distances		The contactors can be assembled side by side					
Fixing							
On rail according to IEC 60715, EN 60715		35 x 15 mm or 75 x 25 mm					
By screws (not supplied)		2 x M6 screws placed diagonally				2 x M6 screws placed diagonally	

AX185 ... AX370 3-pole contactors

Technical data

General technical data

Contactor types	AC operated	AX185	AX205	AX260	AX300	AX370
Rated insulation voltage Ui acc. to IEC 60947-4-1		1000 V				
Rated impulse withstand voltage Uimp.		8 kV				
Ambient air temperature close to contactor						
Operation Fitted with thermal overload relay		-25...+55 °C (1)				
Without thermal overload relay		-40...+70 °C				
Storage		-40 to +70 °C				
Climatic withstand		acc. to IEC 60068-2-30				
Maximum operating altitude (without derating)		3000 m				
Shock withstand acc. to IEC 60068-2-27 and EN 60068-2-27 Mounting position 1		1/2 sinusoidal shock for 11 ms: no change in contact position, closed or open position (2)				
	Shock direction					
	A	5 g				
	B1	5 g				
	B2	5 g				
	C1	5 g				
	C2	5 g				

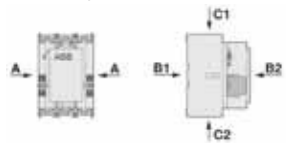

(1) The max. operational current is 182A for AX205 with TA200DU-200
 (2) These values are not valid for rail mounting with contactors AX95 ... AX150.

Magnet system characteristics

Contactor types	AC operated	AX185	AX205	AX260	AX300	AX370
Coil operating limits acc. to IEC 60947-4-1	AC supply	at $\theta \leq 55$ °C 0.85...1.1 x Uc		At $\theta \leq 70$ °C 0.85 ... 1.1 x Uc max		
		Please also refer to "Mounting characteristics and conditions for use"				
AC control voltage 50/60 Hz						
Rated control circuit voltage Uc	at 50 Hz	24...440 V				
	at 60 Hz	24...440 V				
Coil consumption	Average pull-in value	50 Hz	550 VA	-	-	-
		60 Hz	600 VA	-	-	-
		50/60 Hz (1)	700 VA / 650 VA	475 VA	-	-
	Average holding value	50 Hz	35 VA / 11 W	-	-	-
		60 Hz	40 VA / 12 W	-	-	-
		50/60 Hz (1)	44 VA / 13 W	17.5 VA	-	-
Drop-out voltage		approx. 40...65 % of Uc		55% of Uc min.		
Operating time						
Between coil energization and:	N.O. contact closing	13...27 ms		30...60 ms		
	N.C. contact opening	8...22 ms		-		
Between coil de-energization and:	N.O. contact opening	5...10 ms		45...80 ms		
	N.C. contact closing	9...13 ms		-		

(1) 50/60 Hz coils: see "Coil voltage code table".









Mounting characteristics and conditions for use

Contactor types	AC operated	AX185	AX205	AX260	AX300	AX370
Mounting positions						
		Max. add-on N.O. or N.C. auxiliary contacts: see accessory fitting details for 3-pole contactor AX185 ... AX370				
Control voltage / Ambient temperature						
Mounting positions 1, 1±30°, 2, 3, 4, 5	at $\theta \leq 55$ °C	0.85...1.1 x Uc				
	at 55 °C $\leq \theta \leq 70$ °C	0.85...1.1 x Uc				
6	at $\theta \leq 55$ °C	Unauthorized				
	at $\theta \leq 55$ °C	Unauthorized				
Mounting distances		The contactors can be assembled side by side				
Fixing						
On rail according to IEC 60715, EN 60715		-				
By screws (not supplied)		4 x M5				

AX09 ... AX40 3-pole contactors

Technical data









Connecting characteristics

Contactor types	AC operated	AX09	AX12	AX18	AX25	AX32	AX40
Main terminals							
		Screw terminals with cable clamp				Screw terminals with double connector 2 x (5.6 x 6.5 mm)	
Connection capacity (min. ... max.)							
Main conductors (poles)							
 Rigid	Solid ($\leq 4 \text{ mm}^2$)	1 x	1...4 mm ²			1...6 mm ²	2.5...16 mm ²
 Stranded ($\geq 6 \text{ mm}^2$)			1...4 mm ²			1...6 mm ²	2.5...16 mm ²
 Flexible with ferrule		1 x	0.75...2.5 mm ²			0.75...6 mm ²	2.5...10 mm ²
		2 x	0.75...2.5 mm ²			0.75...6 mm ²	2.5...10 mm ²
	Flexible with insulated ferrule	1 x	-			0.75...4 mm ²	2.5...10 mm ²
		2 x	-			0.75...2.5 mm ²	2.5...10 mm ²
 Bars or lugs		L <	7.7 mm			9.6 mm	-
		I >	3.7 mm			3.7 mm	-
Tightening torque	Recommended		1 Nm / 9 lb.in			1.2 Nm / 11 lb.in	2.3 Nm / 20 lb.in
	Max.		1.2 Nm			1.5 Nm	2.60 Nm
Auxiliary conductors (built-in auxiliary terminals + coil terminals)							
 Rigid solid		1 x	1...4 mm ²				
		2 x	1...4 mm ²				
 Flexible with ferrule		1 x	0.75...2.5 mm ²				
		2 x	0.75...2.5 mm ²				
 Lugs		L <	7.7 mm			8 mm	
		I >	3.7 mm			3.7 mm	
Tightening torque							
Coil terminals	Recommended		1 Nm / 9 lb.in				
	Max.		1.20 Nm				
Built-in auxiliary terminals	Recommended		1 Nm / 9 lb.in				1 Nm / 9 lb.in
	Max.		1.20 Nm				1.20 Nm
Degree of protection acc. to IEC 60947-1 / EN 60947-1 and IEC 60529							
Main terminals			IP20 (only front side)				
Coil terminals			IP20				IP20
Built-in auxiliary terminals			IP20 (only front side)				IP20
Screw terminals							
Main terminals			Delivered in open position, screws of unused terminals must be tightened				
			M3.5				M5
		Screwdriver type	Flat Ø 5.5 / Pozidriv 2				Flat Ø 6.5 / Pozidriv 2
Coil terminals			M3.5				
		Screwdriver type	Flat Ø 5.5 / Pozidriv 2				
Built-in auxiliary terminals			M3.5				
		Screwdriver type	Flat Ø 5.5 / Pozidriv 2				

AX50 ... AX150 3-pole contactors

Technical data

Connecting characteristics







Contactor types	AC operated	AX50	AX65	AX80	AX95	AX115	AX150
Main terminals							
		"Screw terminals with single connector (13 x 10 mm)"			"Screw terminals with single connector (14 x 14 mm)"		
Connection capacity (min. ... max.)							
Main conductors (poles)							
	Rigid	Solid ($\leq 4 \text{ mm}^2$)	1 x	6...50 mm ²		10...95 mm ²	
				Stranded ($\geq 6 \text{ mm}^2$)	2 x 6...25 mm ²		6...35 mm ²
	Flexible with ferrule		1 x		6...35 mm ²		10...70 mm ² (1)
			2 x	6...16 mm ²		6...35 mm ² (1)	
	Flexible with insulated ferrule		1 x	6...35 mm ²		10...70 mm ² (1)	
			2 x	6...16 mm ²		6...35 mm ² (1)	
	Bars or lugs		L <	-		30 mm (2)	
			I >	-		6 mm	
Tightening torque	Recommended	4.00 Nm / 35 lb.in			8 Nm / 71 lb.in		
	Max.	4.50 Nm			9 Nm		
Auxiliary conductors (built-in auxiliary terminals + coil terminals)							
	Rigid solid		1 x	1...4 mm ²		0.75...2.5 mm ²	
			2 x	1...4 mm ²		0.75...2.5 mm ²	
	Flexible with ferrule		1 x	1...2.5 mm ²		0.75...2.5 mm ²	
			2 x	0.75...2.5 mm ²			
	Lugs		L <	8 mm ²			
			I >	3.7 mm ²			
Tightening torque							
Coil terminals	Recommended	1 Nm / 9 lb.in					
	Max.	1.2 Nm					
Built-in auxiliary terminals	Recommended	-					
	Max.	-					
Degree of protection							
acc. to IEC 60947-1 / EN 60947-1 and IEC 60529							
Main terminals		IP 10					
Coil terminals		IP20					
Built-in auxiliary terminals		-					
Screw terminals							
Main terminals	Delivered in open position, screws of unused terminals must be tightened						
			M6	M8			
Coil terminals	Screwdriver type	Flat Ø 6.5 / Pozidriv 2			Hexagon socket (s = 4 mm)		
			M3.5				
Built-in auxiliary terminals	Screwdriver type	Flat Ø 5.5 / Pozidriv 2					
			-				
	Screwdriver type	-					

(1) AX95 -AX150: use flexible without ferrule.
 (2) With LW110 enlargement piece, see "Accessories".

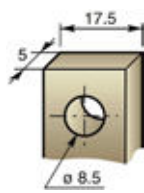
AX185 ... AX205 3-pole contactors

Technical data













Connecting characteristics

Contactor types		AC operated	AX185	AX205
2	Main terminals			
	Flat type			
Connection capacity (min. ... max.)				
Main conductors (poles)				
	Rigid with connector	Single for Cu cable	6...185 mm ²	
		Single for Al/Cu cable	25...150 mm ²	
		Double for Al/Cu cable	-	
	Bars or lugs		L < 24 mm	
			Ø > 8 mm	
	Tightening torque	Recommended	18 Nm / 160 lb.in	
		Max.	20 Nm	
Auxiliary conductors (built-in auxiliary terminals + coil terminals)				
	Rigid solid	1 x	1...4 mm ²	
		2 x	1...4 mm ²	
	Flexible with ferrule	1 x	0.75...2.5 mm ²	
		2 x	0.75...2.5 mm ²	
	Lugs	L <	8 mm ²	
		l >	3.7 mm ²	
	Tightening torque			
	Coil terminals	Recommended	1 Nm / 9 lb.in	
		Max.	1.2 Nm	
Degree of protection acc. to IEC 60947-1 / EN 60947-1 and IEC 60529				
	Main terminals		IP00	
	Coil terminals		IP20	
Screw terminals				
	Main terminals		M8	
			Screw and bolts	
	Coil terminals (delivered in open position)		M3.5	
		Screwdriver type	Flat Ø 5.5 / Pozidriv 2	

AX260 ... AX370 3-pole contactors

Technical data

Connecting characteristics

Contactor types	AC operated	AX260	AX300	AX370
Main terminals				
Flat type				
				
Connection capacity (min. ... max.)				
Main conductors (poles)				
	Rigid with connector	Cu cable Stranded	1x	16...300 mm ²
		Clamp type		1SDA055016R1
		Tightening torque		25 Nm
		Cu cable Stranded	2x	70...185 mm ²
		Clamp type		1SCA022194R0890 (OZXB4)
		Tightening torque		22 Nm
		Al cable Stranded	1x	185...240 mm ²
		Clamp type		1SDA055020R1
		Tightening torque		43 Nm
		Cu cable Flexible	1x	16...240 mm ²
		Clamp type		1SDA055016R1
		Tightening torque		25 Nm
		Cu cable Flexible	2x	70...185 mm ²
		Clamp type		1SCA022194R0890 (OZXB4)
		Tightening torque		22 Nm
	Bars or lugs	Double for Al/Cu cable		70...185 mm ²
		W <		32mm (1.260 in)
		Ø >		10mm (.394 in)
		Socket type		LL...included
		Tightening torque		28Nm / 248 lb.in
Auxiliary conductors				
(Coil terminals)				
	Rigid /Stranded		1 x	1...4 mm ²
			2 x	1...4 mm ²
	Flexible		1 x	0.75...2.5 mm ²
			2 x	0.75...2.5 mm ²
	Flexible with non insulated		1 x	0.75...2.5 mm ²
			2 x	0.75...2.5 mm ²
	Flexible with insulated ferrule		1 x	0.75...2.5 mm ²
			2 x	0.75...2.5 mm ²
	Lugs		L <	8 mm
			I >	3.5 mm
		Stripping length		9 mm
		Tightening torque		1.00 Nm / 9 lb.in
Degree of protection				
acc. to IEC 60947-1 / EN 60947-1 and IEC 60529				
	Main terminals			IP00
	Coil terminals			IP20
Screw terminals				
	Main terminals			M10
		Screwdriver type		Screws and bolts
	Coil terminals (delivered in open position)			M3.5
		Screwdriver type		Flat Ø 5.5 mm / Pozidriv 2

AX09 ... AX40 3-pole contactors

Technical data

Built-in auxiliary contacts according to IEC - Other auxiliary contacts see "Accessories"

Contactor types	AC operated	AX09	AX12	AX18	AX25	AX32	AX40
Rated operational voltage U_e max.		690 V					
Rated frequency (without derating)		50/60 Hz					
Conventional free air thermal current I_{th} $\theta \leq 40$ °C		16 A					
I_e / Rated operational current AC-15 acc. to IEC 60947-5-1	24-127 V 50/60 Hz	6 A					
	220-240 V 50/60 Hz	4 A					
	380-440 V 50/60 Hz	3 A					
	500 V 50/60 Hz	2 A					
	690 V 50/60 Hz	2 A					
Making capacity AC-15		10 x I_e AC-15 acc. to IEC 60947-5-1					
Breaking capacity AC-15		10 x I_e AC-15 acc. to IEC 60947-5-1					
I_e / Rated operational current DC-13 acc. to IEC 60947-5-1	24 V DC	6 A / 144 W					
	48 V DC	2.8 A / 134 W					
	72 V DC	2 A / 144 W					
	110 V DC	1.1 A / 121 W					
	125 V DC	1.1 A / 138 W					
	220 V DC	0.55 A / 121 W					
	250 V DC	0.55 A / 138 W					
Short-circuit protection device gG type fuse		10 A					
Rated short-time withstand current I_{sw}	for 1.0 s	100 A					
	for 0.1 s	140 A					
Minimum switching capacity with failure rate acc. to IEC 60947-5-4		12 V / 3 mA					
Non-overlapping time between N.O. and N.C. contacts		≥ 2 ms					
Power dissipation per pole at 6 A		0.1 W					
Max. electrical switching frequency	AC-15	1200 cycles/h					
	DC-13	900 cycles/h					
Mechanically linked contacts acc. to annex L of IEC 60947-5-1		Built-in N.O. or N.C. auxiliary contacts and additional N.O. or N.C. auxiliary contacts of 4-pole CA5X are mechanically linked contacts.					
Mirror contacts acc. to annex F of IEC 60947-4-1		Built-in N.C. auxiliary contacts or additional N.C. auxiliary contacts (CA5X, CAL5X-11) are mirror contacts.					

AX09 ... AX370 3-pole contactors

Terminal marking and positioning

AX09 ... AX150 contactors - AC operated

Standard devices without addition of auxiliary contacts

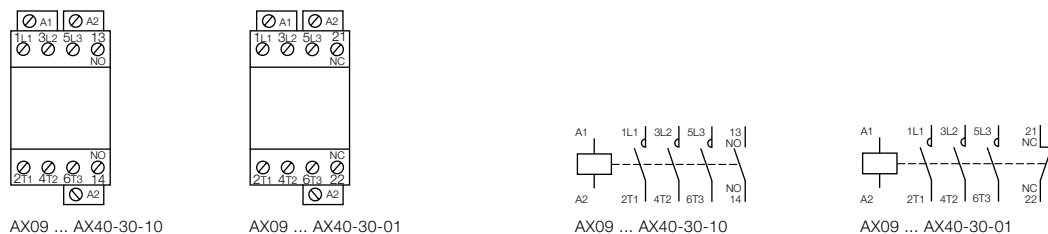

Standard devices with factory mounted auxiliary contacts



Other possible contact combinations with auxiliary contacts added by the user

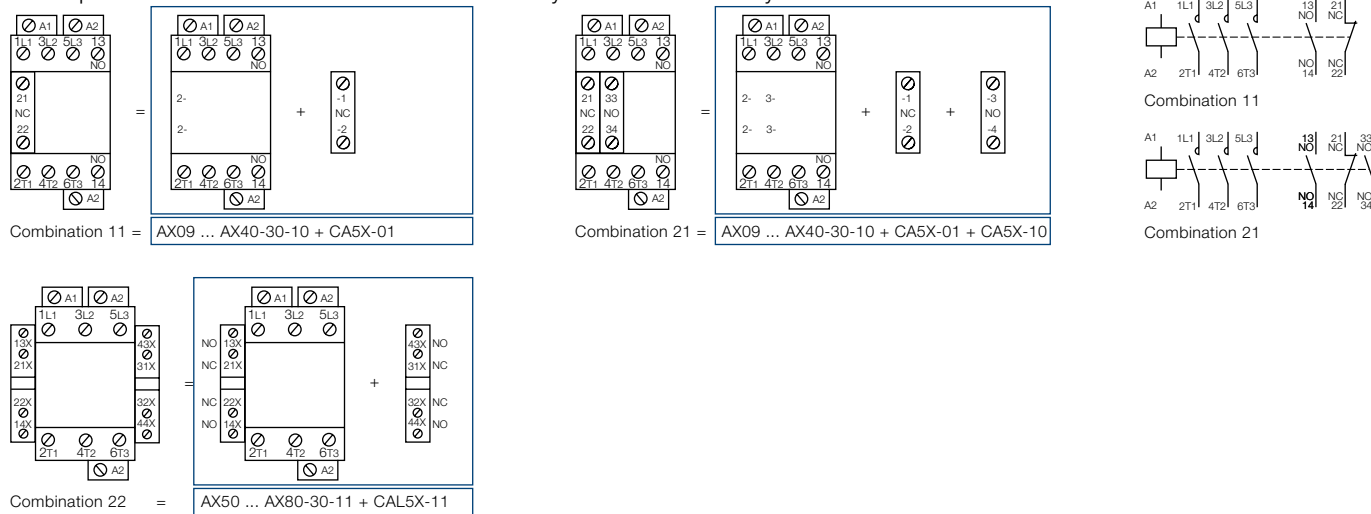

AX185 ... AX370 contactors - AC operated

Standard devices with factory mounted auxiliary contacts

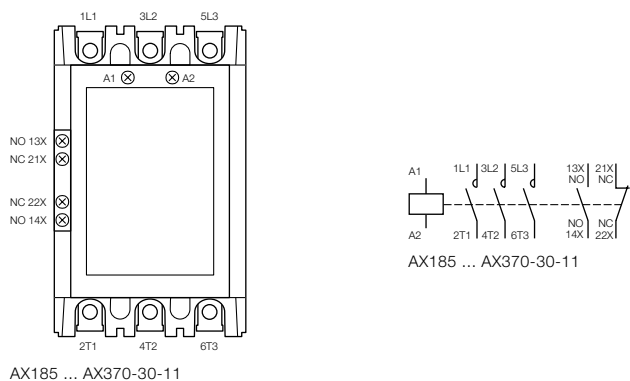

AX contactor

Dimensions

Main dimensions mm

2

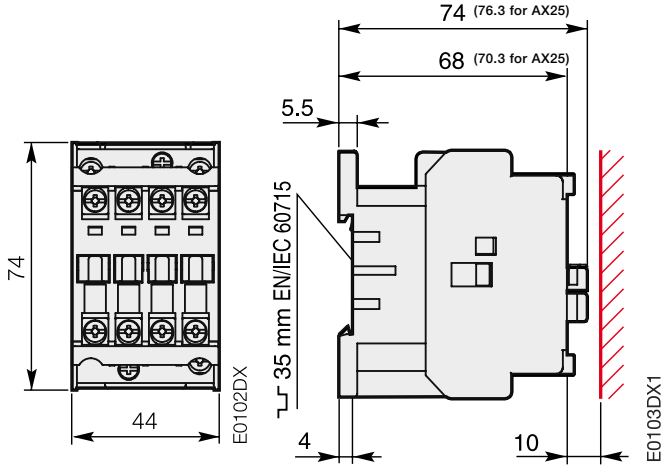

AX09, AX12, AX18, AX25, NX..E

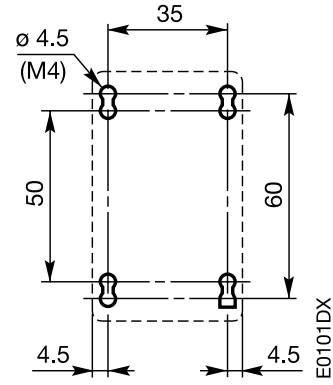

Drilling plan AX09, AX12, AX18, AX25, NX..E

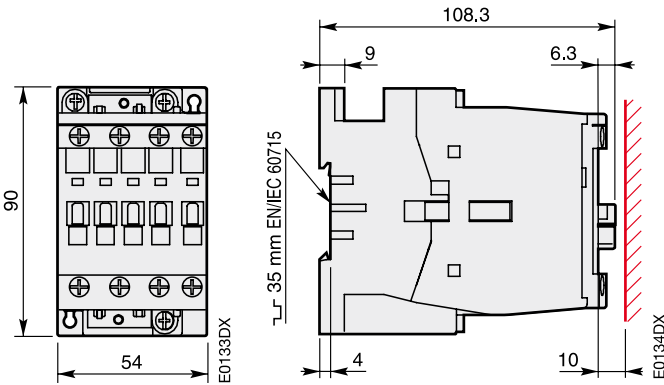

AX32, AX40

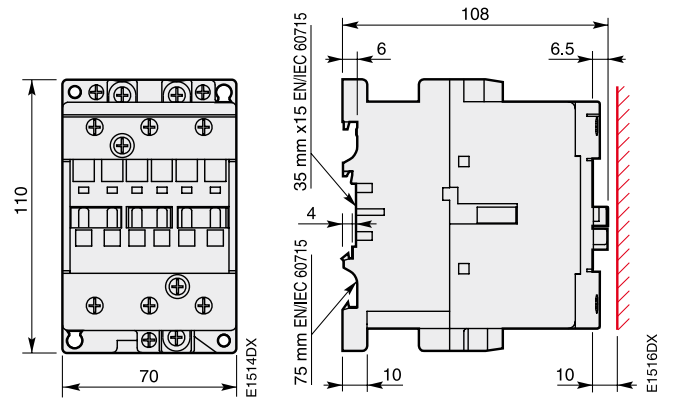

AX50, AX65, AX80

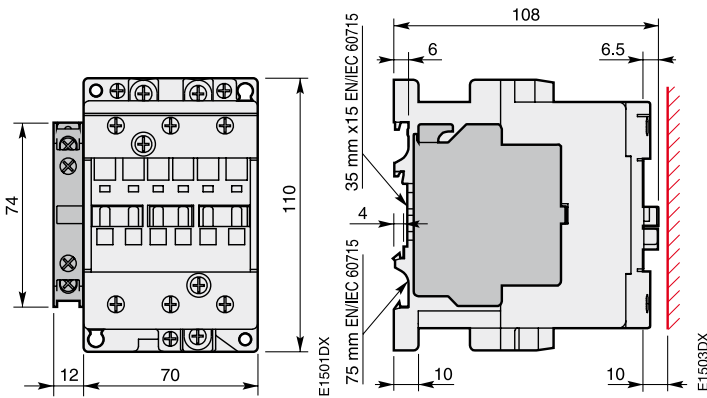

AX50, AX65, AX80 + CAL5X - 11

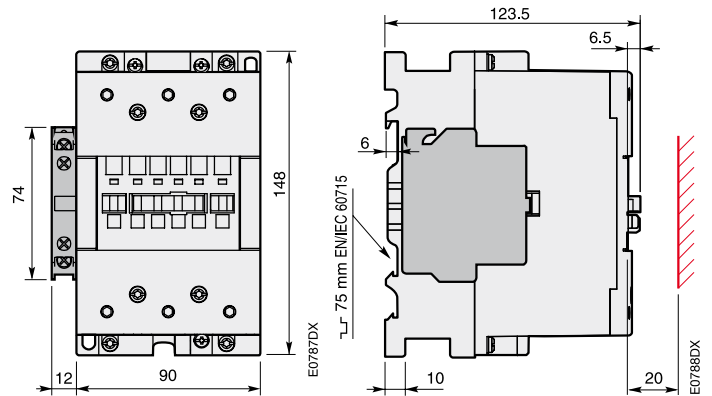

AX95, AX115, AX150 + CAL18X-11

AX contactor

Dimensions

Main dimensions mm

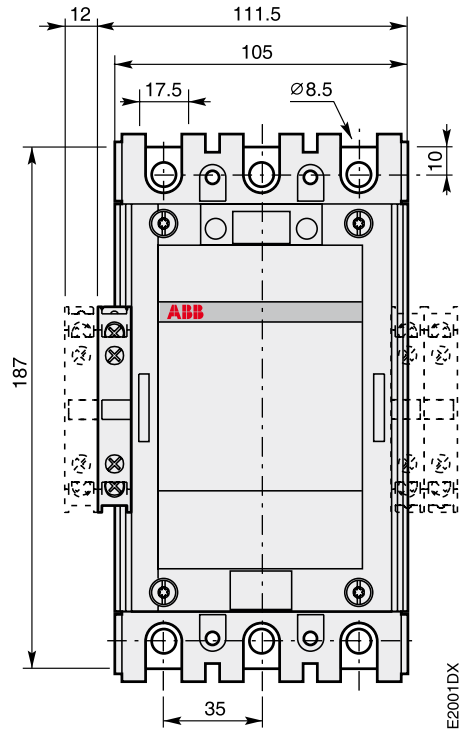

AX185, AX205 + CAL18X-11

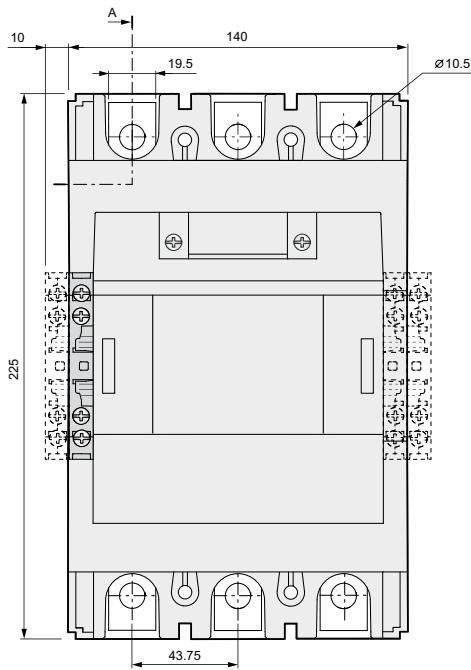
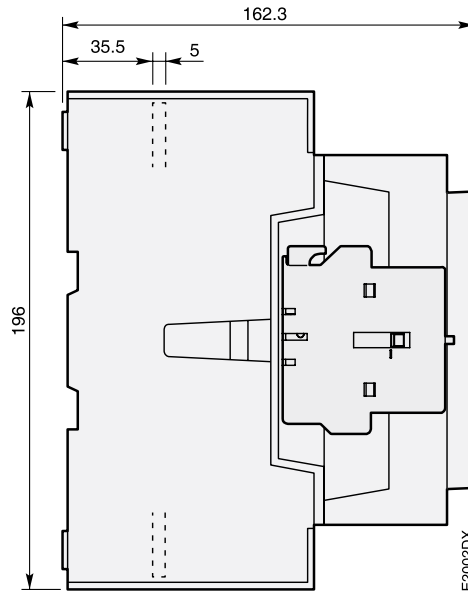

AX260, AX300, AX370-30-00 + CAL19 2-pole contact block
AX260, AX300, AX370-30-11

AX260, AX300, AX370

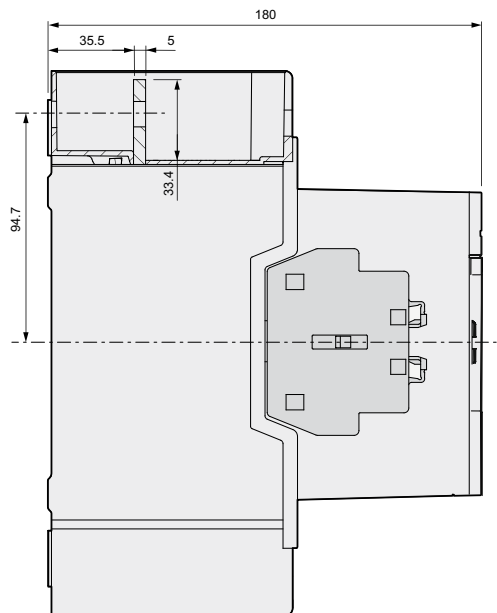

Star-delta starting of three-phase asynchronous motors

Contactor selection

General

Star-delta starting is the most common method to reduce the starting current of a motor. This system can be used on all the squirrel cage motors, which are normally used in delta connection.

2

In this type of starting, it is recommended to choose motors having high starting torque i.e. much higher than the resistive torque in order to reach sufficient high speed when the motor is connected in star.

Star-delta starting

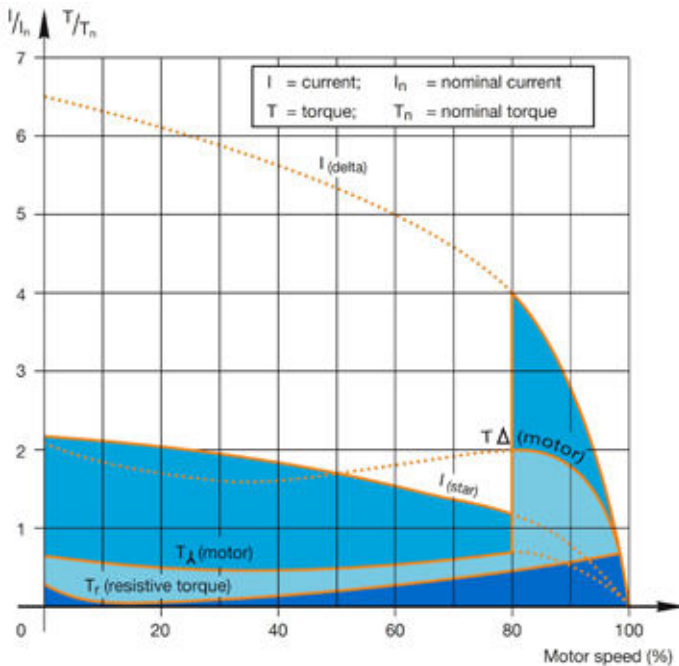

Technical Data

When starting:

- inrush current is reduced to a third of direct starting current
- motor torque is reduced to a third or even less of direct starting torque.

Transient current is generated when switching from star to delta connection.

Utilization

During the initial starting phase ("star" connection), the resistive torque of the driven load must remain, irrespective of speed, less than the "star" motor torque until "star-delta" switching occurs.

This starting mode is therefore ideal for machines having low starting torque such as:

- pumps
- centrifugal compressors
- wood-working machines, etc.

In order to prevent a high current peak, at least 85 % of nominal speed must be reached before switching from star to delta.

Precautions

Motor nominal voltage in delta connection must be equal to that of the mains.

Example:

A motor for 415 V star-delta starting must be designed for 415 V in "delta" connection. Its usual designation is "415 V / 690 V motor". The motor must be constructed with 6 terminal windings.

Sequence

Starting is a three-stage process:

1st stage - "Star" connection

Press the "On" button on the control circuit to close the KM2 "star" contactor. The KM1 "line" contactor then closes and the motor starts. Countdown of programmed starting time (normally 6 to 16 s) then begins.

2nd stage - "Star" to "Delta" switching

When the programmed starting time is over, the KM2 "star" contactor opens.

3rd stage - "Delta" connection

For AX09 ... AX205, A transition time (or dwelling time) of 50 ms is fixed between opening of the "star" contactor and closing of the "delta" contactor by the use of TE5S timer. This prevents short circuit between "star" and "delta".

For AX260 ... AX370, an on-delay timer without dwelling time (CT-ERS.21S, 1SVR730100R0300) is enough to countdown the programmed starting time (6 to 10s) during "Star connection". The use of a star-delta timer including dwelling time is not permitted.

Note: An electrical interlock between star and delta is mandatory such as VE 5 or through auxiliary contacts.

Furthermore, in open transition, the current interruption may reach up to 95 ms: it shall be checked that this duration is compatible with the application i.e. mainly if the decreasing in rotation speed is acceptable during the starting phase.

Star-delta starting of three-phase asynchronous motors

Contactor selection

Rated operational power						Max. Starting time from cold state (3) seconds	Line contactor type	Delta contactor type	Star contactor type	Overload relay (4) type	Timer
220-230 V AC-3 kW	240 V AC-3 kW	380-400 V AC-3 kW	415 V AC-3 kW	500 V AC-3 kW	660-690 V AC-3 kW						
4	4	7.5	5.5	5.5	7.5	15	AX09	AX09	AX09	TA25DU M	TE5S
5.5	5.5	7.5	11	7.5	7.5	15	AX12	AX12	AX09	TA25DU M	TE5S
7.5	7.5	15	15	11	11	15	AX18	AX18	AX12	TA25DU M	TE5S
11	11	22 (1)	22	15	15	15	AX25	AX25	AX18	TA25DU M	TE5S
15	15	30	30	30	30	15	AX32	AX32	AX25	TA25DU M	TE5S
18.5	22	37	37	37	37	30	AX40	AX40	AX32	TA42DU M	TE5S
22	30	45	45	55	55	30	AX50	AX50	AX32	TA75DU M	TE5S
30	37	55	55	55	55	30	AX65	AX65	AX40	TA75DU M	TE5S
37	45	55	75	75	75	30	AX80	AX80	AX50	TA75DU M	TE5S
45	55	75/90 (2)	90	90	90	20	AX95	AX95	AX65	TA110DU	TE5S
55	55	90/110 (2)	110	110	132	20	AX115	AX115	AX80	TA110DU	TE5S
75	75	132	132	110	132	20	AX150	AX150	AX95	TA200DU	TE5S
90	90	160	160	160	160/200 (2)	20	AX185	AX185	AX115	TA200DU	TE5S
110	110	160	160	200	250	20	AX205	AX205	AX150	TA200DU	TE5S
132	132	250	250	315	400	20	AX260	AX260	AX185	EF370	-
160	160	250	315	355	400/500 (2)	20	AX300	AX300	AX205	EF370	-
200	200	315/355 (2)	355	355	500	20	AX370	AX370	AX260	EF370	-

- Notes:
- (1) To combine with TA25DU-32M
 - (2) Due to different voltage to select different motor
 - (3) Usual time value = 6...16 s.
 - (4) The setting current value is : nominal motor current x 0.58

Power circuit diagram

AX09 ... AX370 contactors

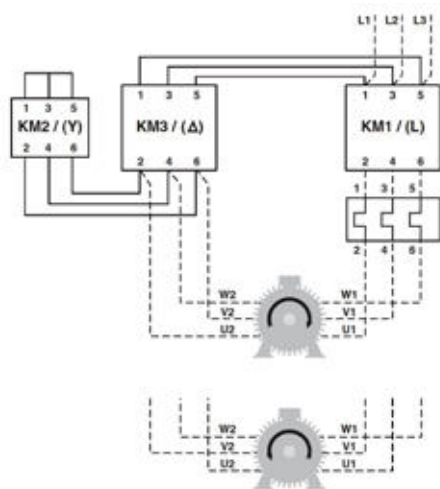

Control circuit diagrams - Remote control

AX09 ... AX205 contactors

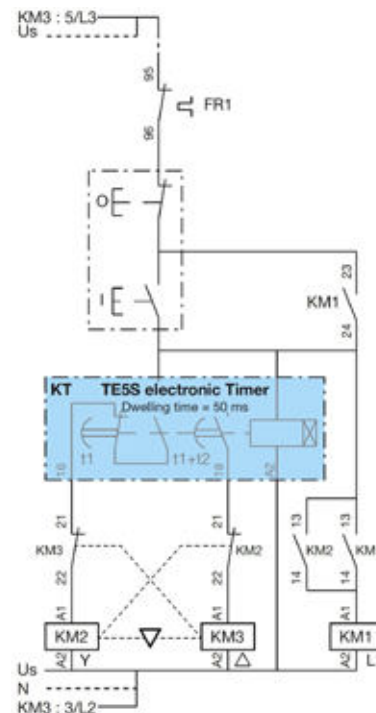

AX260 ... AX370 contactors

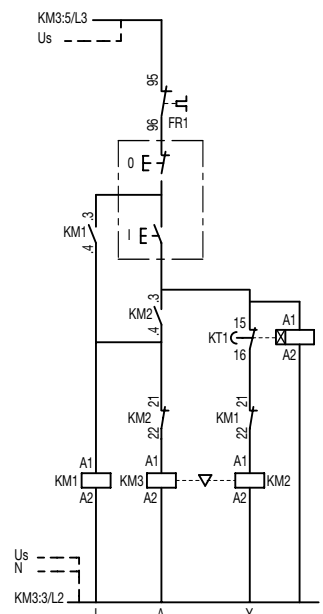

1SYN829571C0201

Contact us

You can find the address of your local sales organisation on the ABB home page



www.abb.fr/lowvoltage

Note

We reserve the right to make technical changes or modify the contents of this document without prior notice.

ABB does not accept any responsibility whatsoever for potential errors or possible lack of information in this document.

We reserve all rights in this document and in the subject matter and illustrations contained therein. Any reproduction, disclosure to third parties or utilization of its contents – in whole or in parts – is forbidden without prior written consent of ABB.

Copyright© 2014 ABB - All rights reserved